

CORNERS

GC0011-BASIC OUTSIDE CORNER DETAIL - A-PANEL
GC0021-BASIC OUTSIDE CORNER DETAIL - R-PANEL
GC0031-BASIC OUTSIDE CORNER DETAIL - REVERSE R-PANEL
GC0041-BASIC INSIDE CORNER DETAIL - A-PANEL
GC0046-INSIDE CORNER DETAIL AT TALLER BUILDING - A-PANEL
GC0051-BASIC INSIDE CORNER DETAIL - R-PANEL
GC0056-INSIDE CORNER DETAIL AT TALLER BUILDING - R-PANEL
GC0061-BASIC INSIDE CORNER DETAIL - REVERSE R-PANEL
GC0066-INSIDE CORNER DETAIL AT TALLER BUILDING - REVERSE R-PANEL
GC0071-INSIDE CORNER TRANSITION - A-PANEL
GC0072-PANEL TERMINATION - A-PANEL
GC0073-PANEL TERMINATION W COVER TRIM - A-PANEL
GC0081-INSIDE CORNER TRANSITION - R-PANEL
GC0082-PANEL TERMINATION - R-PANEL
GC0083-PANEL TERMINATION W COVER TRIM - R-PANEL
GC0091-INSIDE CORNER TRANSITION - REVERSE R-PANEL
GC0092-PANEL TERMINATION - REVERSE R-PANEL
GC0093-PANEL TERMINATION W COVER TRIM - REVERSE R-PANEL
GC0101-INSIDE CORNER TRANSITION - A-PANEL
GC0111-INSIDE CORNER TRANSITION - R-PANEL
GC0121-INSIDE CORNER TRANSITION - REVERSE R-PANEL
GC0160-OUTSIDE CORNER TRANSITION - MASONRY OR EXISTING - A-PANEL
GC0170-OUTSIDE CORNER TRANSITION - MASONRY OR EXISTING - R-PANEL
GC0180-OUTSIDE CORNER TRANSITION - MASONRY /EXISTING - REV R-PANEL
GC0211-ALTERNATE OUTSIDE CORNER DETAIL - A-PANEL
GC0221-ALTERNATE OUTSIDE CORNER DETAIL - R-PANEL
GC0231-ALTERNATE OUTSIDE CORNER DETAIL - REVERSE R-PANEL
GC0241-ALTERNATE INSIDE CORNER DETAIL - A-PANEL
GC0251-ALTERNATE INSIDE CORNER DETAIL - R-PANEL
GC0261-ALTERNATE INSIDE CORNER DETAIL - REVERSE R-PANEL

GC0011 - BASIC OUTSIDE CORNER DETAIL - A-PANEL

[Download the DWG file by clicking here.](#)

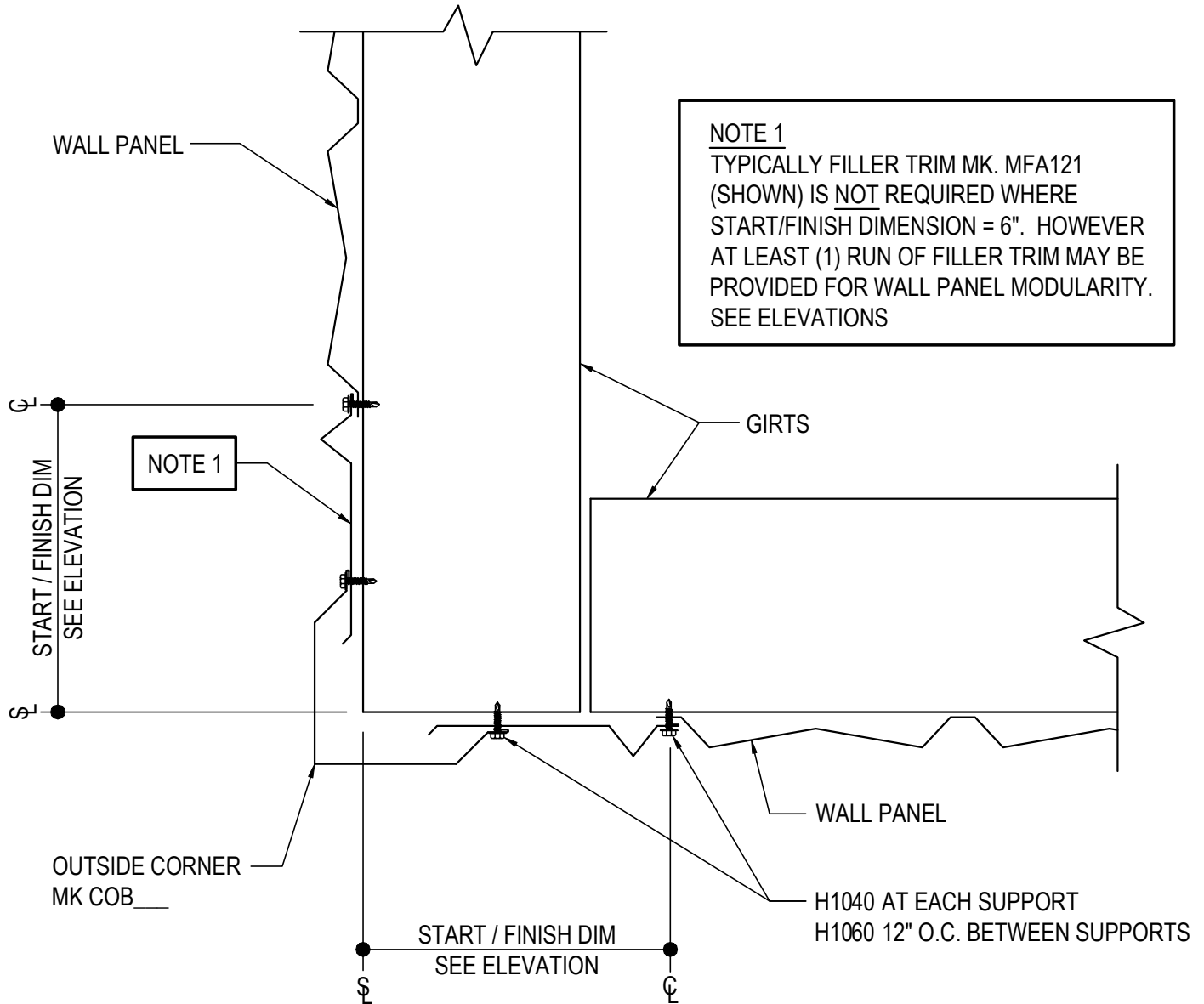

OUTSIDE CORNER DETAIL

GC0011

Detailer Notes:

- 1) N/A

GC0021 - BASIC OUTSIDE CORNER DETAIL - R-PANEL

[Download the DWG file by clicking here.](#)

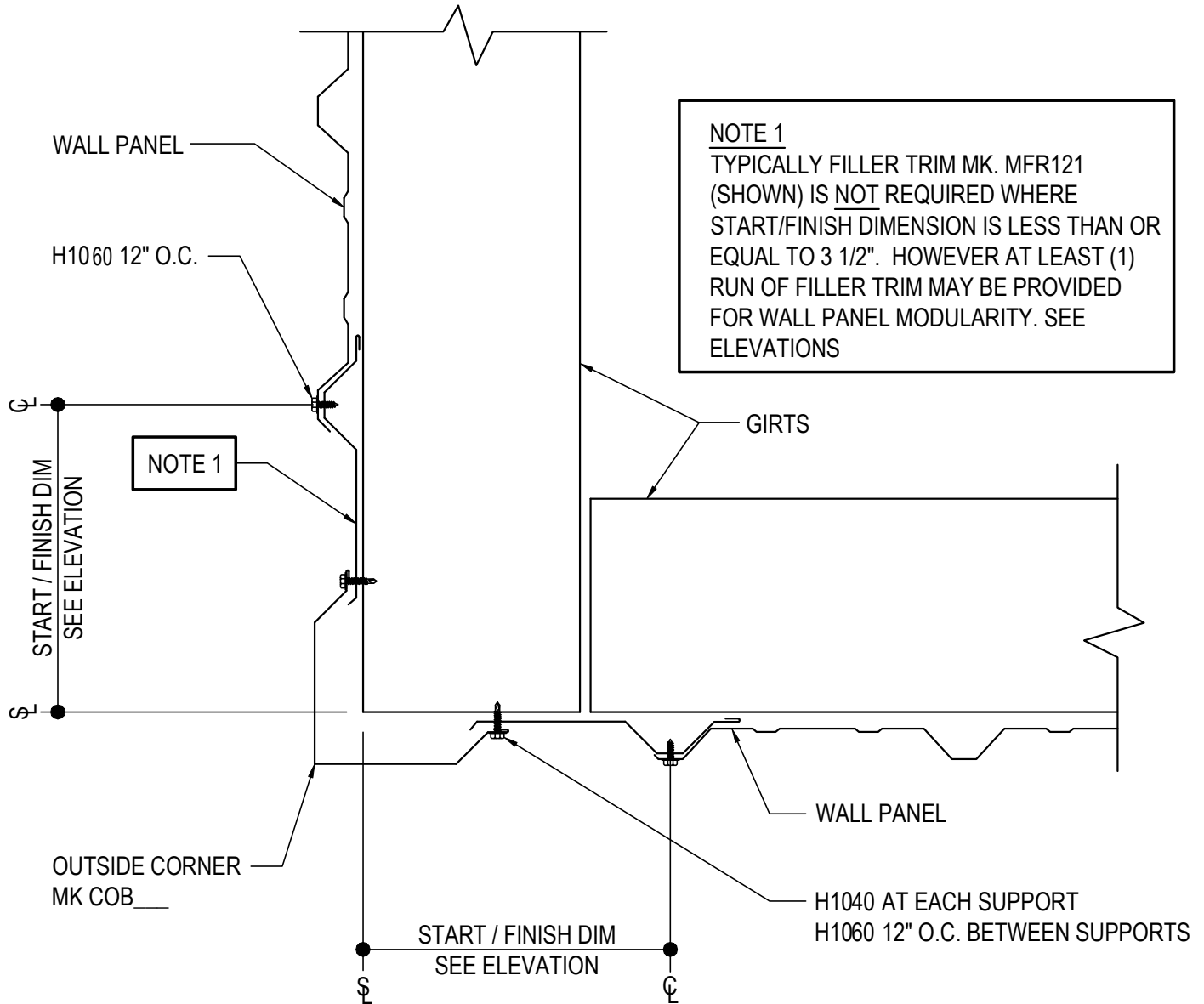

OUTSIDE CORNER DETAIL

GC0021

Detailer Notes:

- 1) N/A

GC0031 - BASIC OUTSIDE CORNER DETAIL - REVERSE R-PANEL

[Download the DWG file by clicking here.](#)

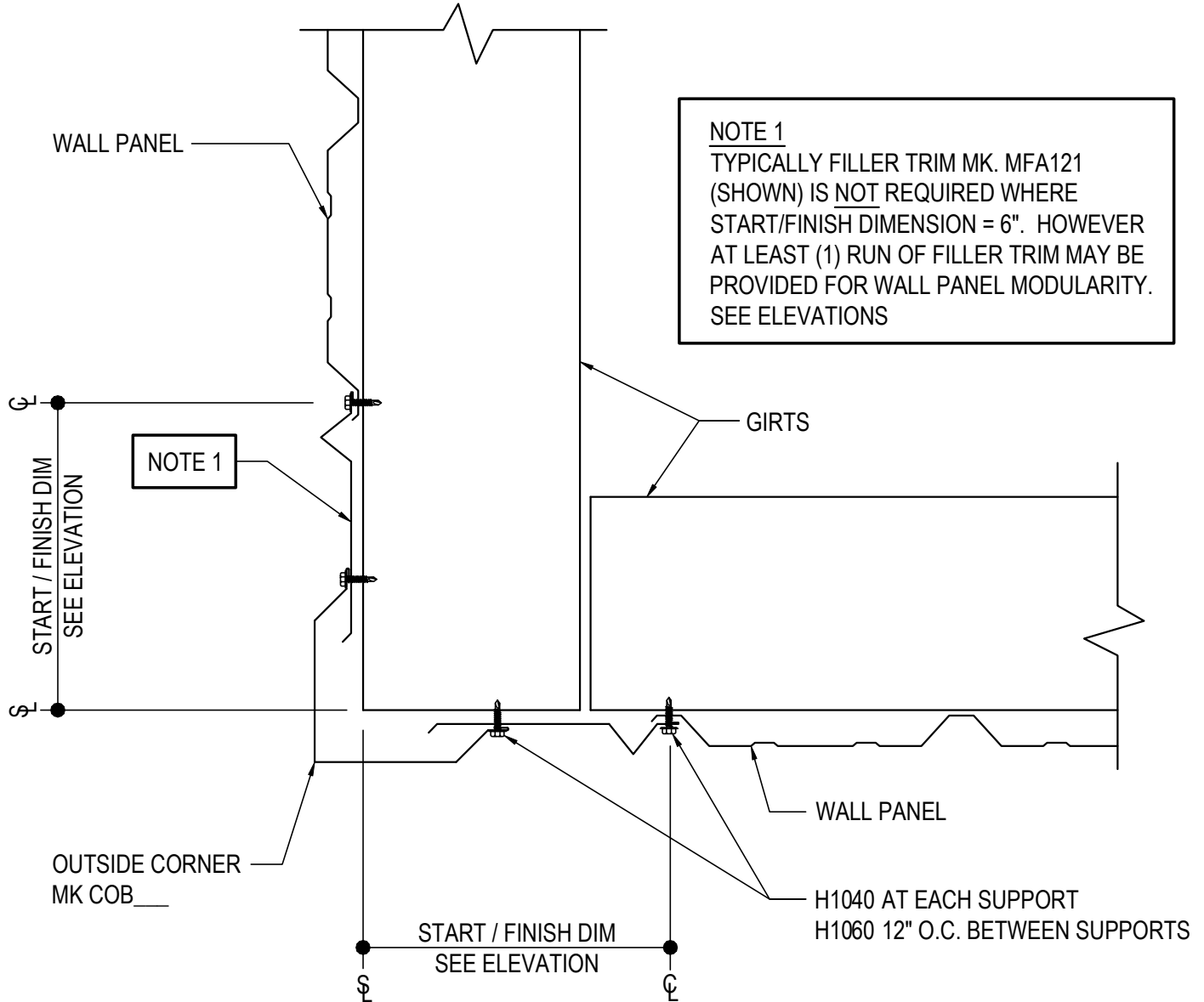

OUTSIDE CORNER DETAIL

GC0031

Detailer Notes:

- 1) N/A

GC0041 - BASIC INSIDE CORNER DETAIL - A-PANEL

[Download the DWG file by clicking here.](#)

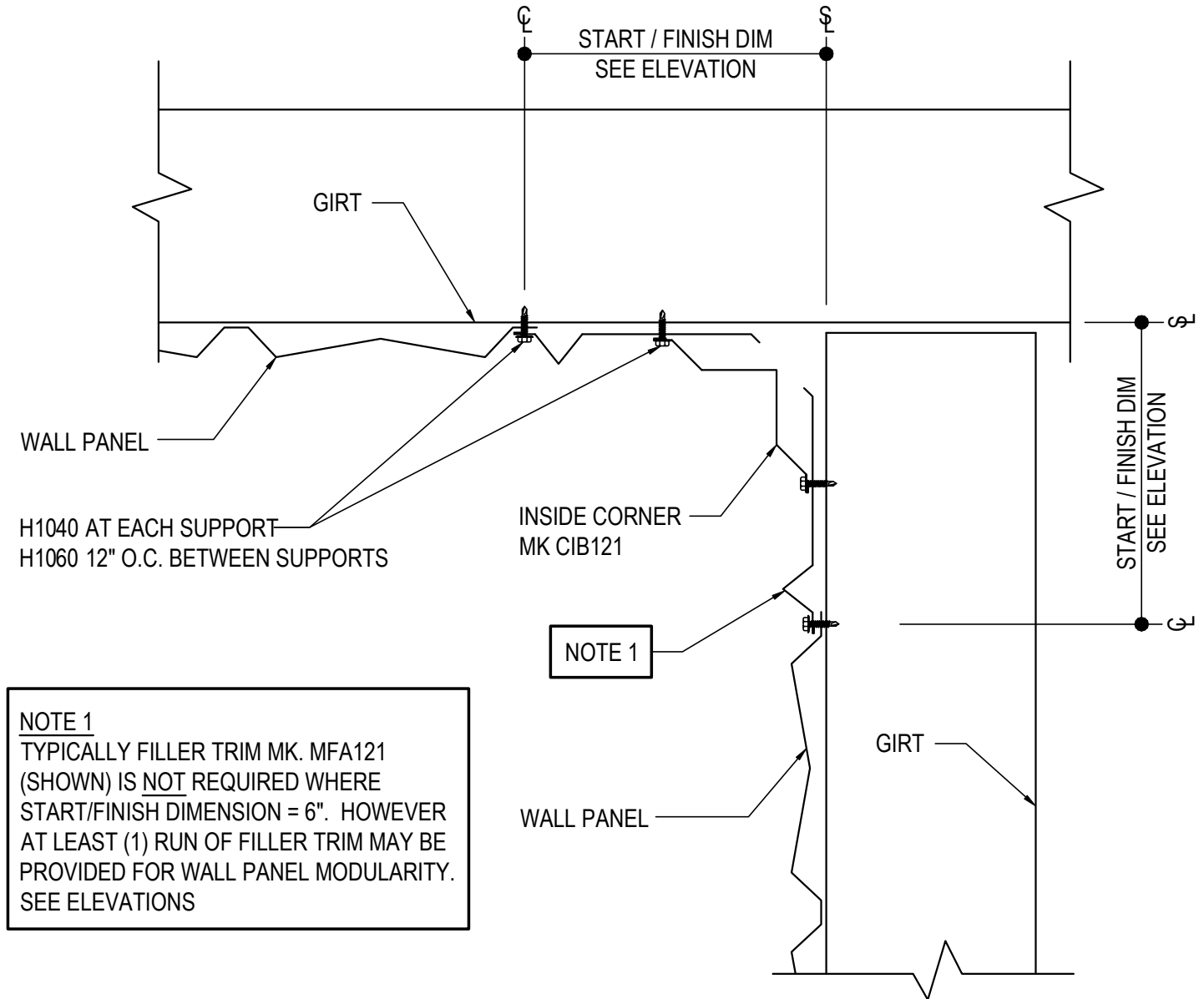

NOTE 1
TYPICALLY FILLER TRIM MK. MFA121 (SHOWN) IS NOT REQUIRED WHERE START/FINISH DIMENSION = 6". HOWEVER AT LEAST (1) RUN OF FILLER TRIM MAY BE PROVIDED FOR WALL PANEL MODULARITY. SEE ELEVATIONS

INSIDE CORNER DETAIL

GC0041

Detailer Notes:

- 1) N/A

GC0046 - INSIDE CORNER DETAIL AT TALLER BUILDING - A-PANEL

[Download the DWG file by clicking here.](#)

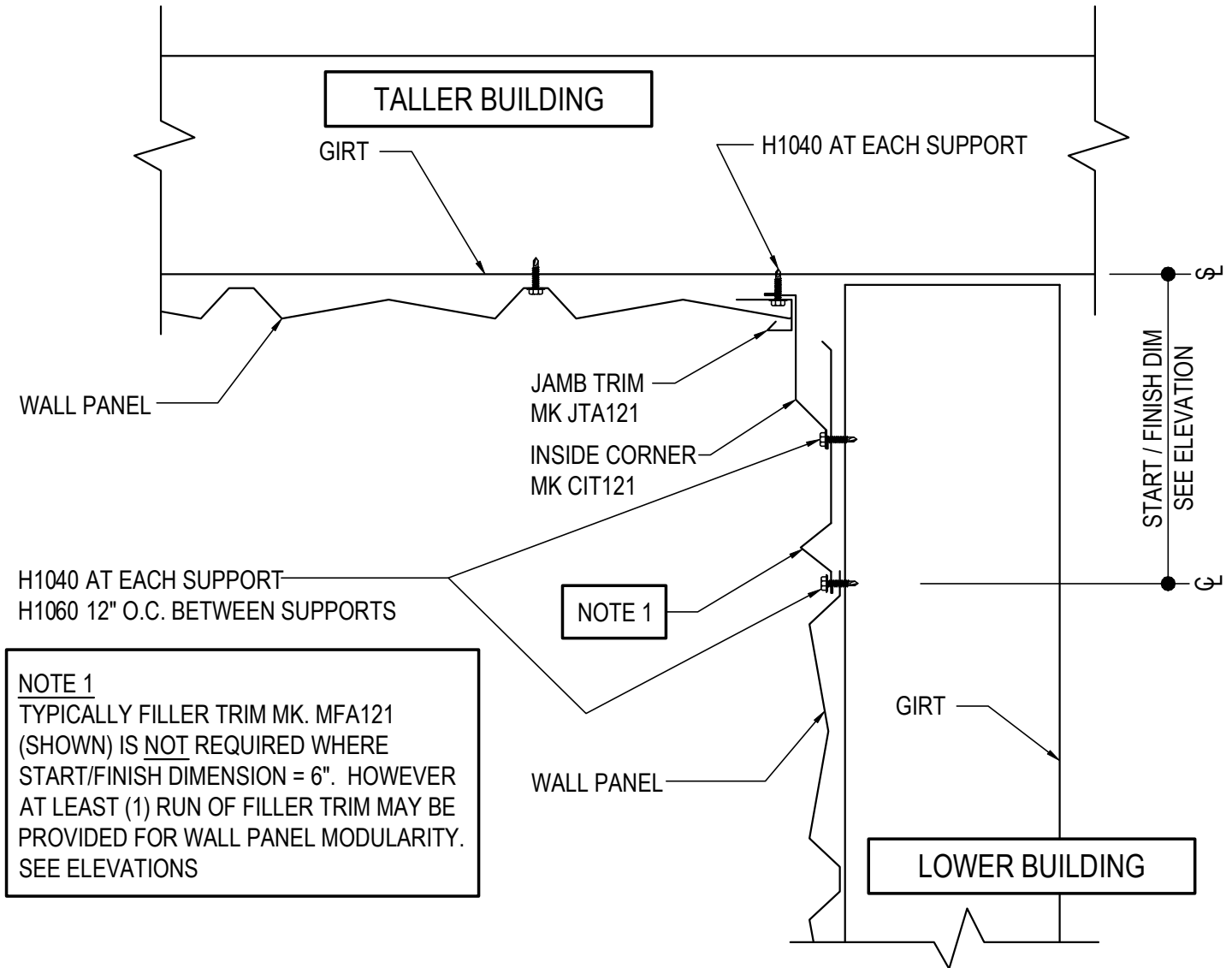

NOTE 1
TYPICALLY FILLER TRIM MK. MFA121 (SHOWN) IS NOT REQUIRED WHERE START/FINISH DIMENSION = 6". HOWEVER AT LEAST (1) RUN OF FILLER TRIM MAY BE PROVIDED FOR WALL PANEL MODULARITY. SEE ELEVATIONS

INSIDE CORNER DETAIL

FIELD CUT PANELS AS REQUIRED

GC0046

Detailer Notes:

- 1) N/A

GC0051 - BASIC INSIDE CORNER DETAIL - R-PANEL

[Download the DWG file by clicking here.](#)

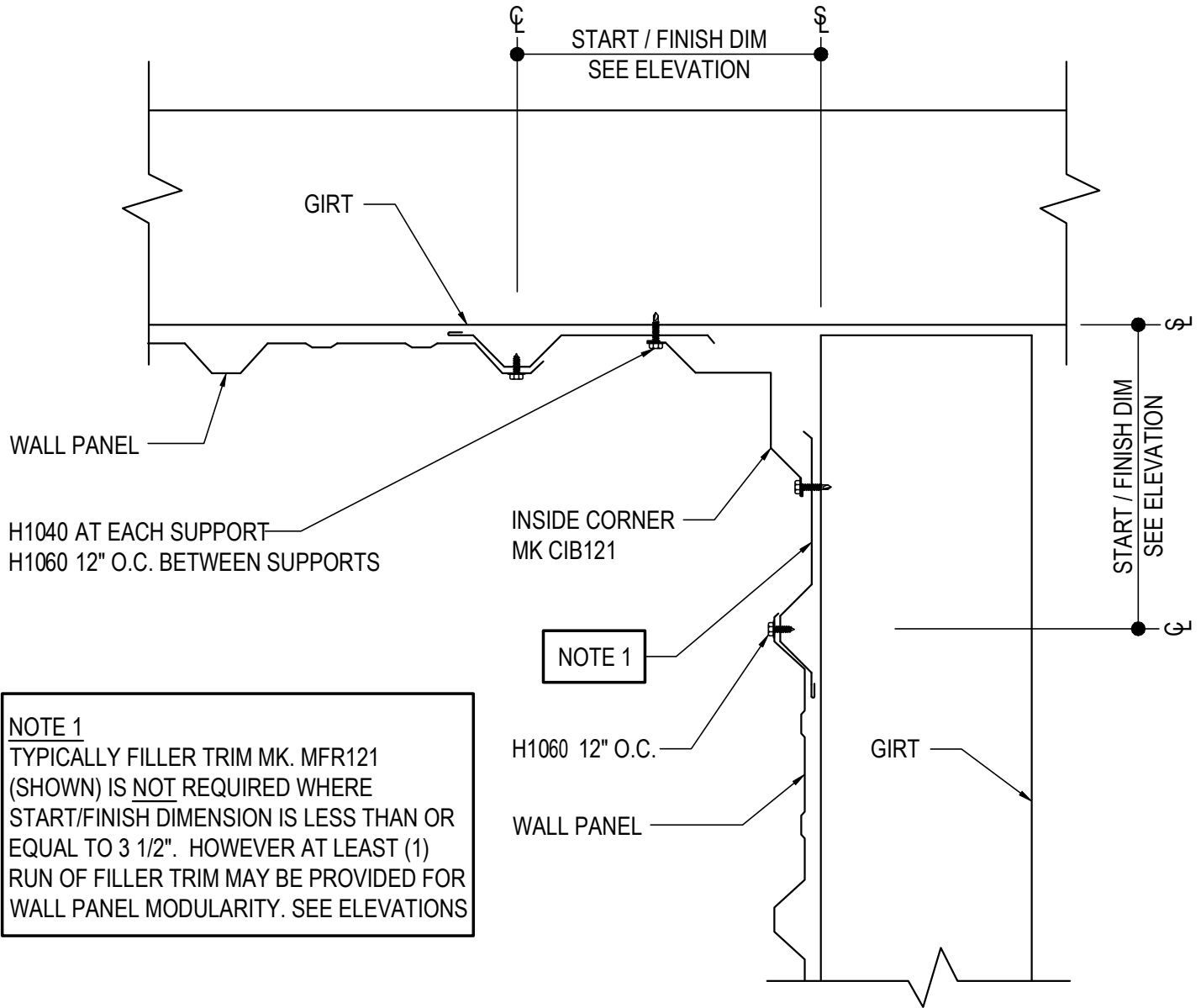

INSIDE CORNER DETAIL

GC0051

Detailer Notes:

- 1) N/A

GC0056 - INSIDE CORNER DETAIL AT TALLER BUILDING - R-PANEL

[Download the DWG file by clicking here.](#)

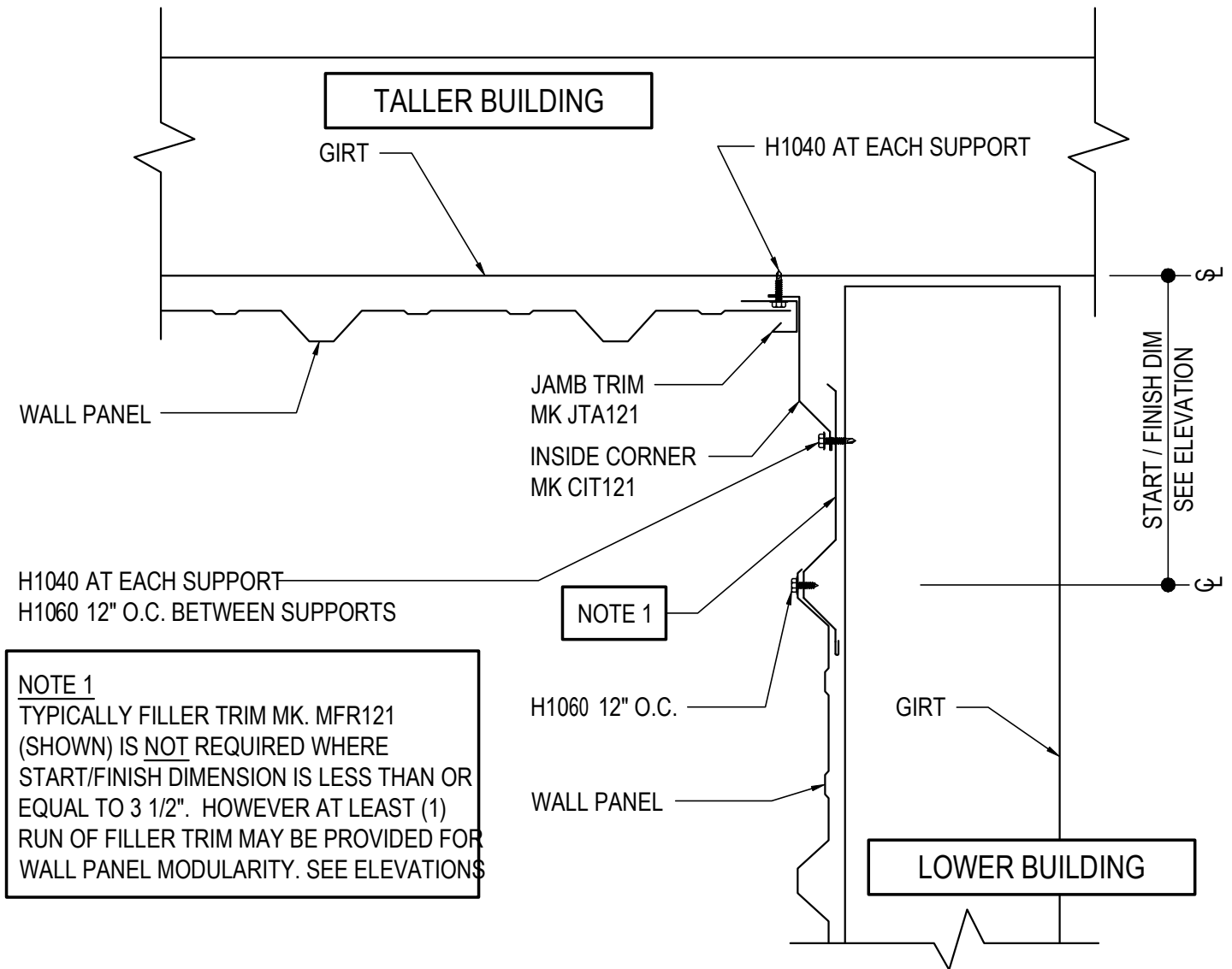

NOTE 1
TYPICALLY FILLER TRIM MK. MFR121 (SHOWN) IS NOT REQUIRED WHERE START/FINISH DIMENSION IS LESS THAN OR EQUAL TO 3 1/2". HOWEVER AT LEAST (1) RUN OF FILLER TRIM MAY BE PROVIDED FOR WALL PANEL MODULARITY. SEE ELEVATIONS

INSIDE CORNER DETAIL

FIELD CUT PANELS AS REQUIRED

GC0056

Detailer Notes:

- 1) N/A

GC0061 - BASIC INSIDE CORNER DETAIL - REVERSE R-PANEL

[Download the DWG file by clicking here.](#)

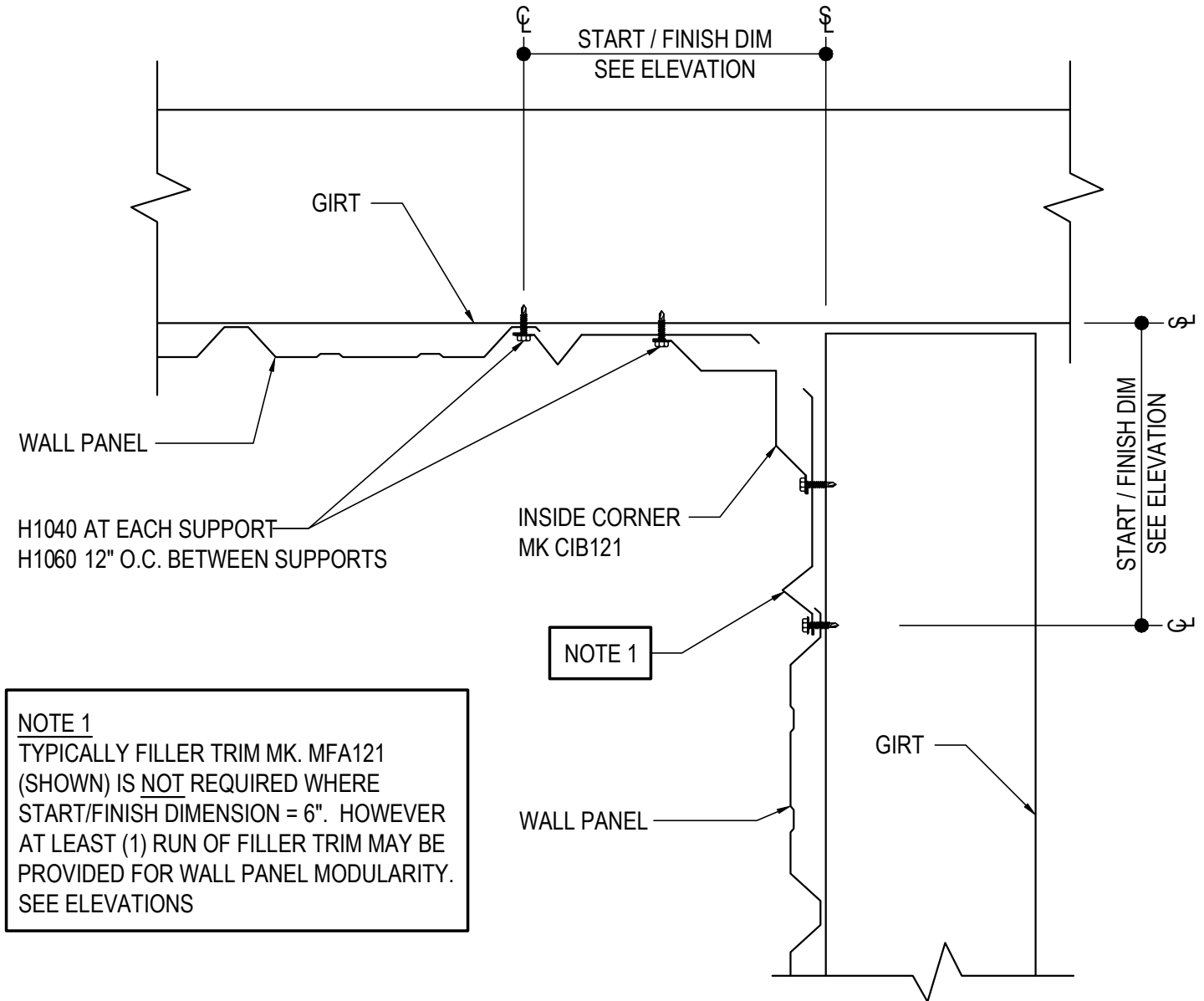

INSIDE CORNER DETAIL

GC0061

Detailer Notes:

- 1) N/A

GC0066 - INSIDE CORNER DETAIL AT TALLER BUILDING - REVERSE R-PANEL

[Download the DWG file by clicking here.](#)

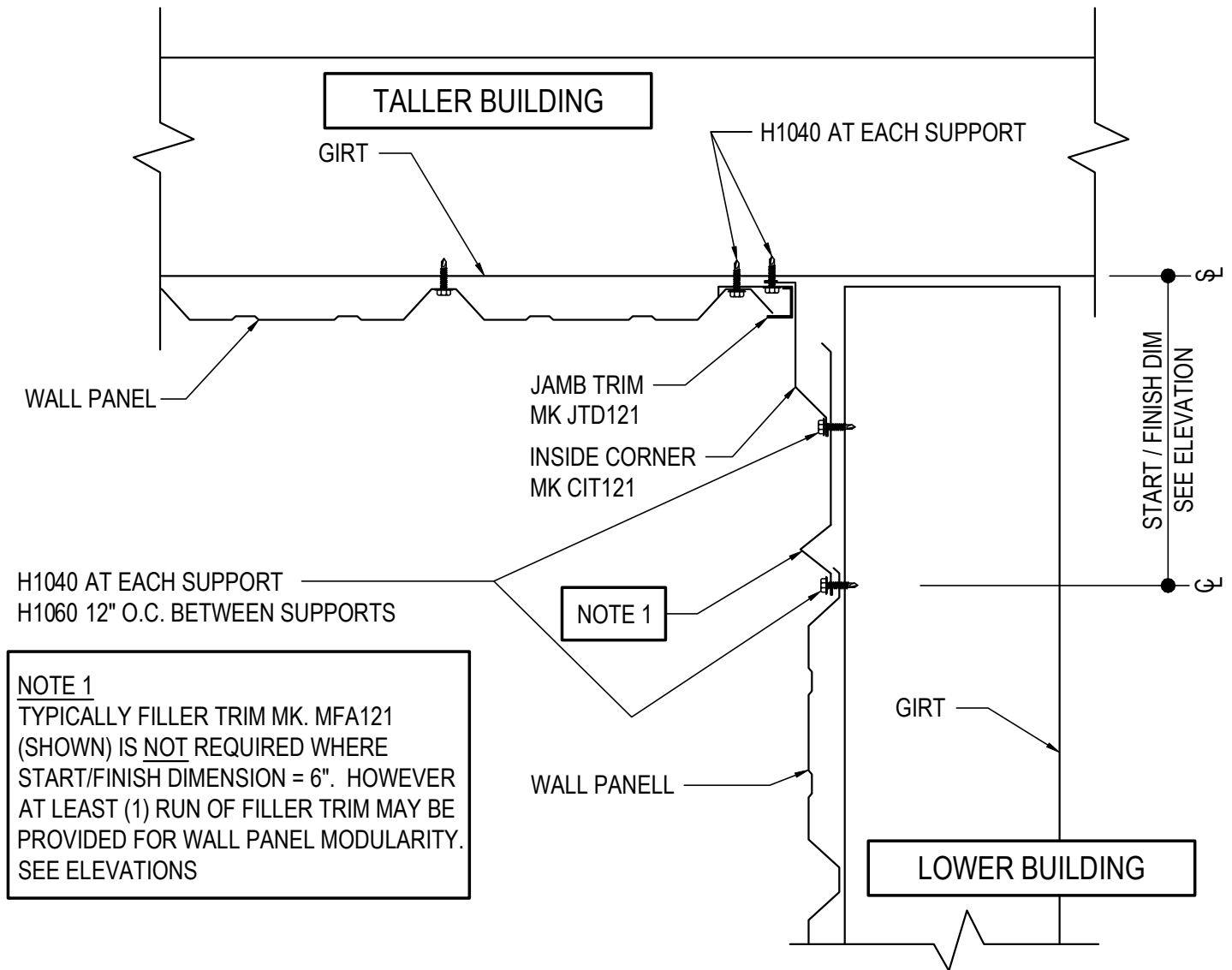

NOTE 1
TYPICALLY FILLER TRIM MK. MFA121 (SHOWN) IS NOT REQUIRED WHERE START/FINISH DIMENSION = 6". HOWEVER AT LEAST (1) RUN OF FILLER TRIM MAY BE PROVIDED FOR WALL PANEL MODULARITY. SEE ELEVATIONS

INSIDE CORNER DETAIL

FIELD CUT PANELS AS REQUIRED

GC0066

Detailer Notes:

- 1) N/A

GC0071 - INSIDE CORNER TRANSITION - A-PANEL

[Download the DWG file by clicking here.](#)

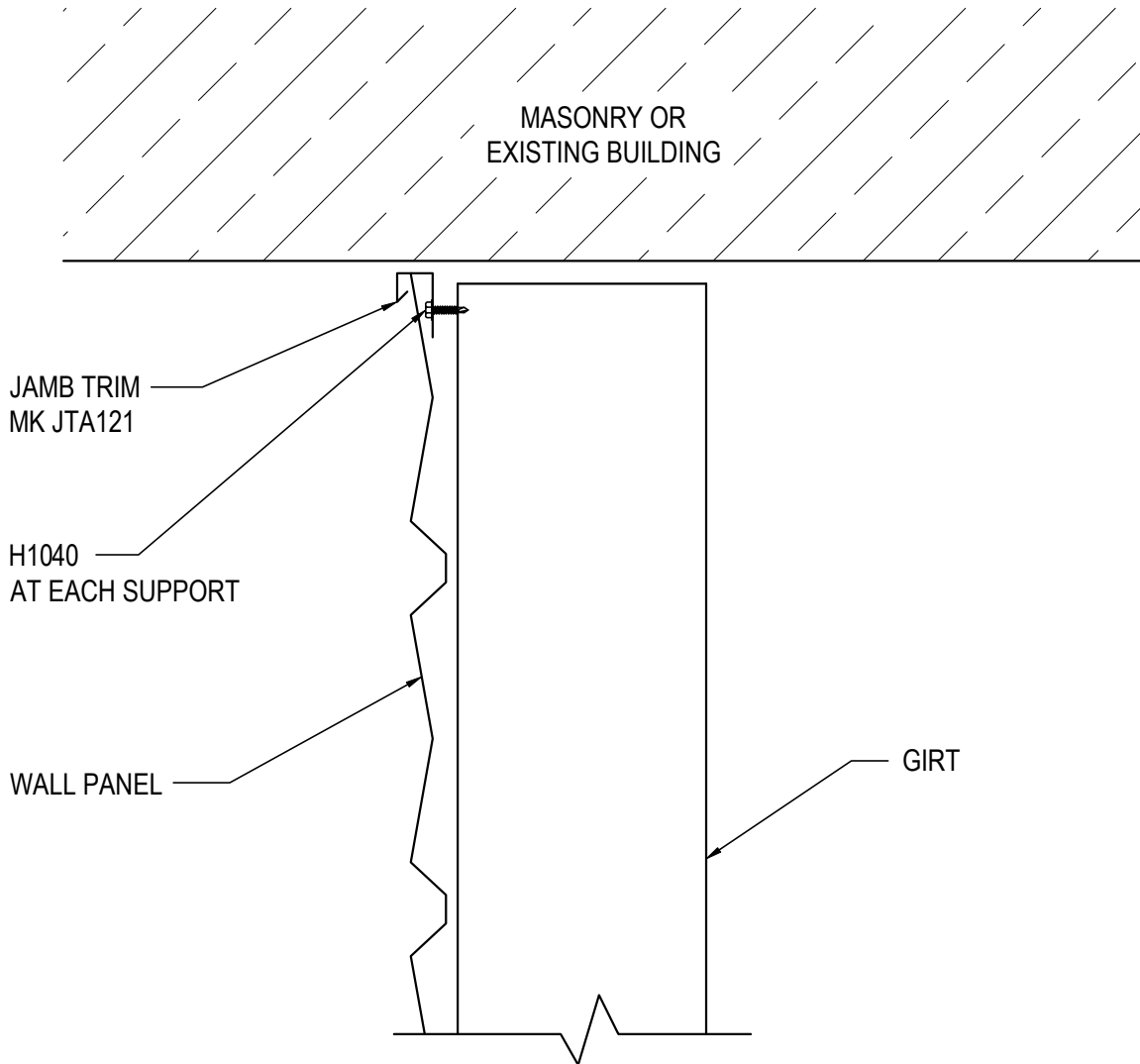

INSIDE CORNER TRANSITION

FIELD CUT PANELS AS REQUIRED

GC0071

Detailer Notes:

- 1) USE DETAIL GC0101 AS THE ALTERNATE TO THIS DETAIL

GC0072 - PANEL TERMINATION - A-PANEL

[Download the DWG file by clicking here.](#)

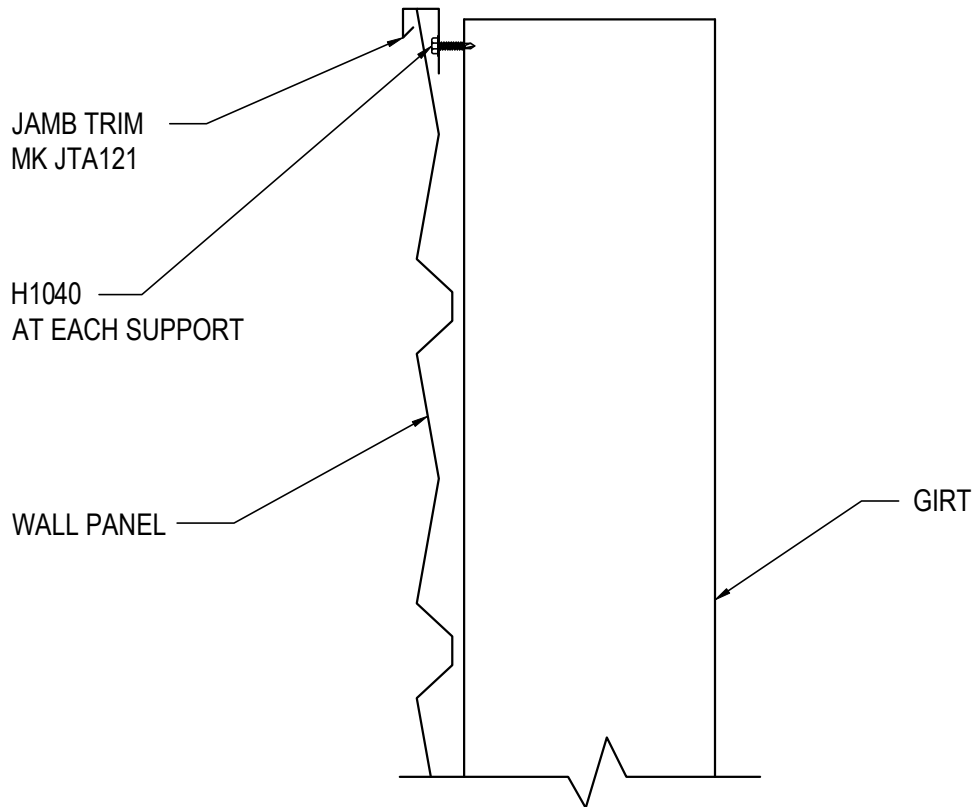

PANEL TERMINATION

FIELD CUT PANELS AS REQUIRED

GC0072

Detailer Notes:

- 1) N/A

GC0073 - PANEL TERMINATION W/ COVER TRIM - A-PANEL

[Download the DWG file by clicking here.](#)

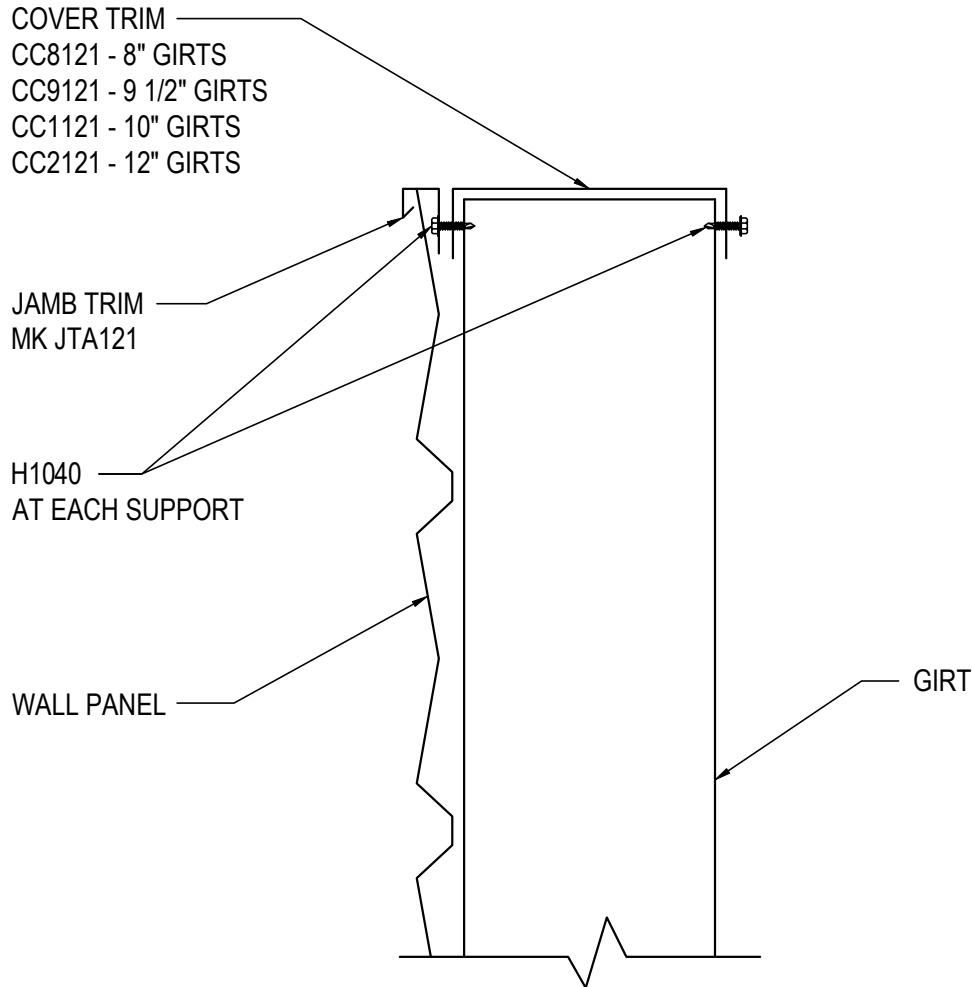

PANEL TERMINATION

FIELD CUT PANELS AS REQUIRED

GC0073

Detailer Notes:

- 1) N/A

GC0081 - INSIDE CORNER TRANSITION - R-PANEL

[Download the DWG file by clicking here.](#)

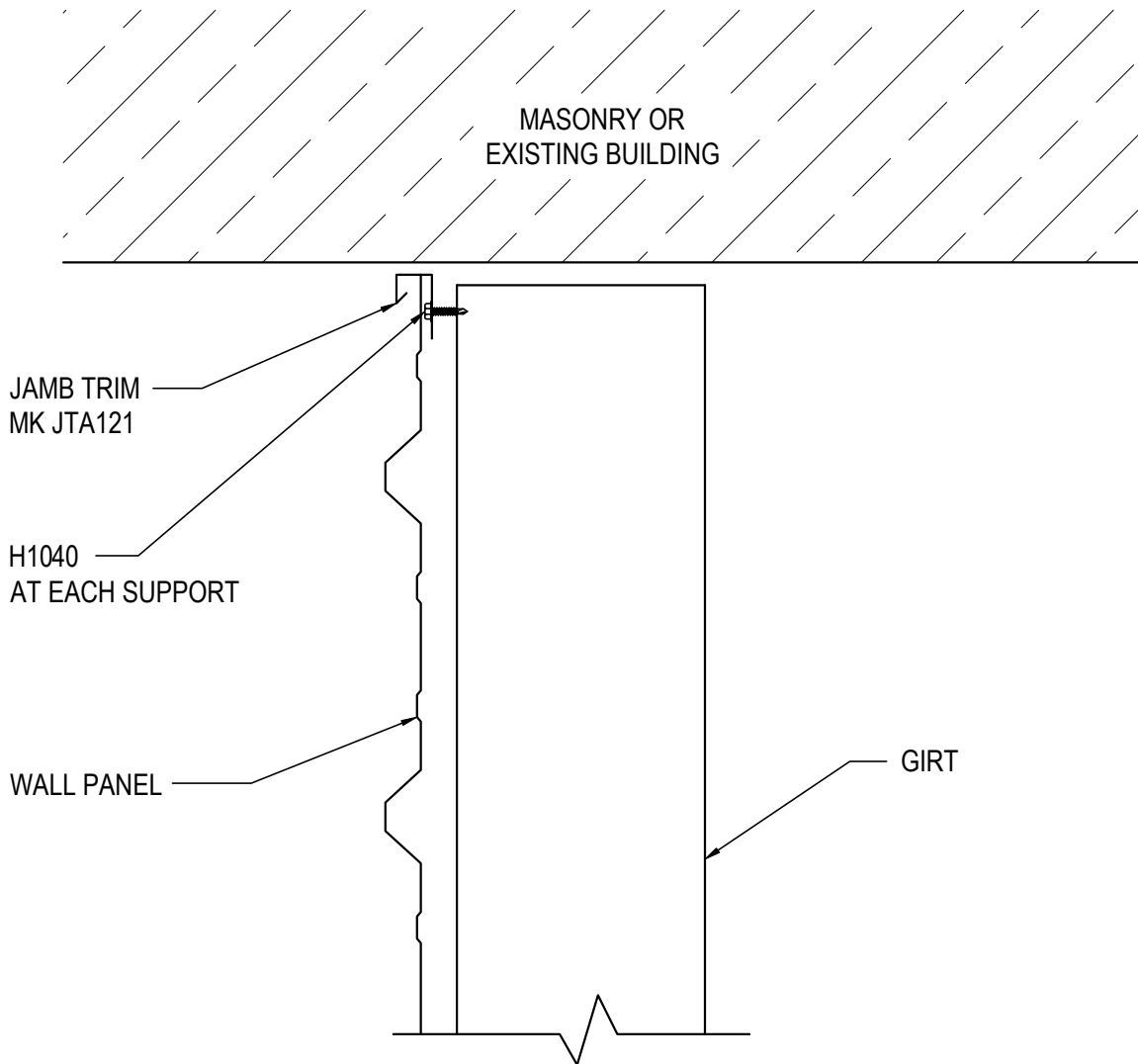

INSIDE CORNER TRANSITION

FIELD CUT PANELS AS REQUIRED

GC0081

Detailer Notes:

- 1) USE DETAIL GC0111 AS THE ALTERNATE TO THIS DETAIL

GC0082 - PANEL TERMINATION - R-PANEL

[Download the DWG file by clicking here.](#)

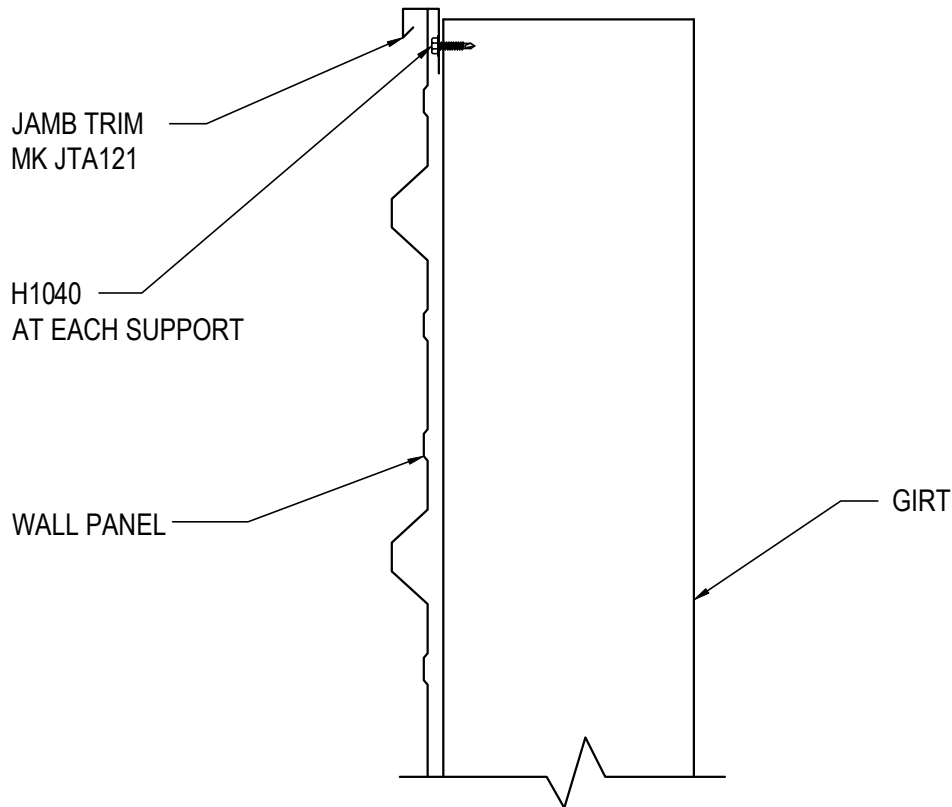

PANEL TERMINATION

FIELD CUT PANELS AS REQUIRED

GC0082

Detailer Notes:

1) N/A

GC0083 - PANEL TERMINATION W/ COVER TRIM - R-PANEL

[Download the DWG file by clicking here.](#)

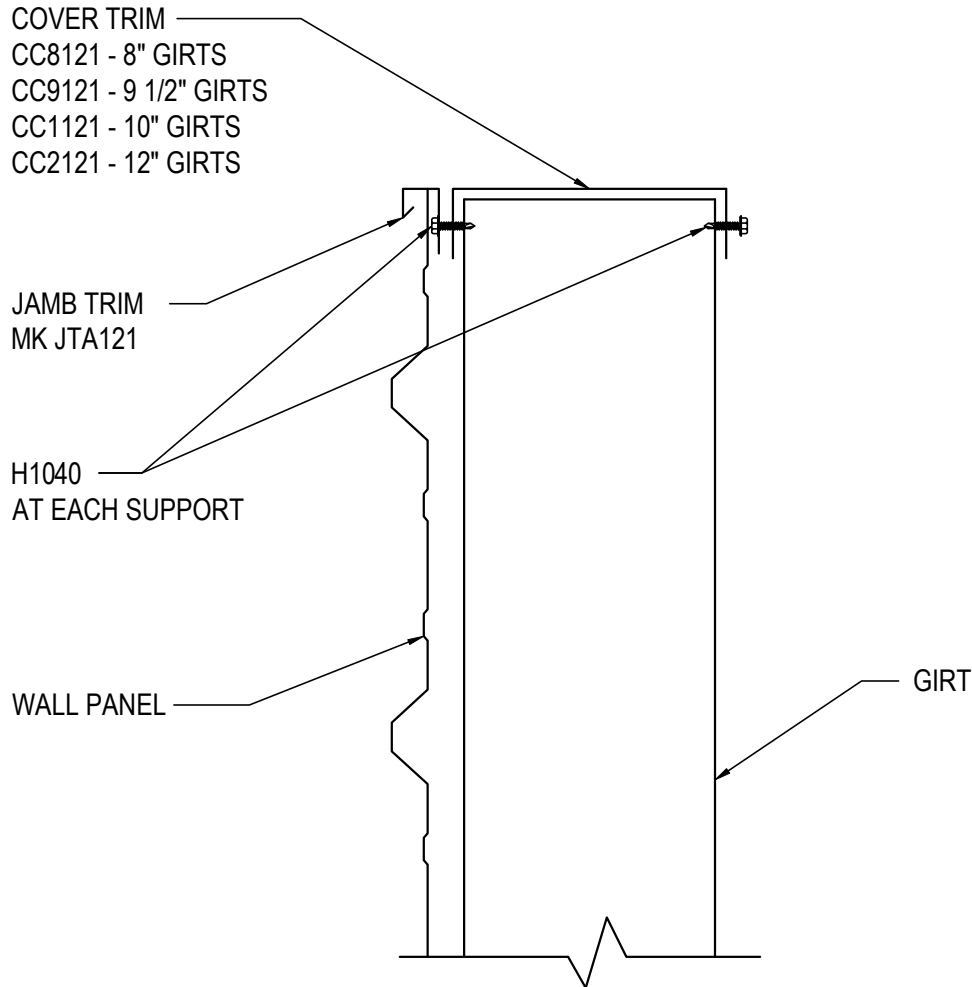

PANEL TERMINATION

FIELD CUT PANELS AS REQUIRED

GC0083

Detailer Notes:

- 1) N/A

GC0091 - INSIDE CORNER TRANSITION - REVERSE R-PANEL

[Download the DWG file by clicking here.](#)

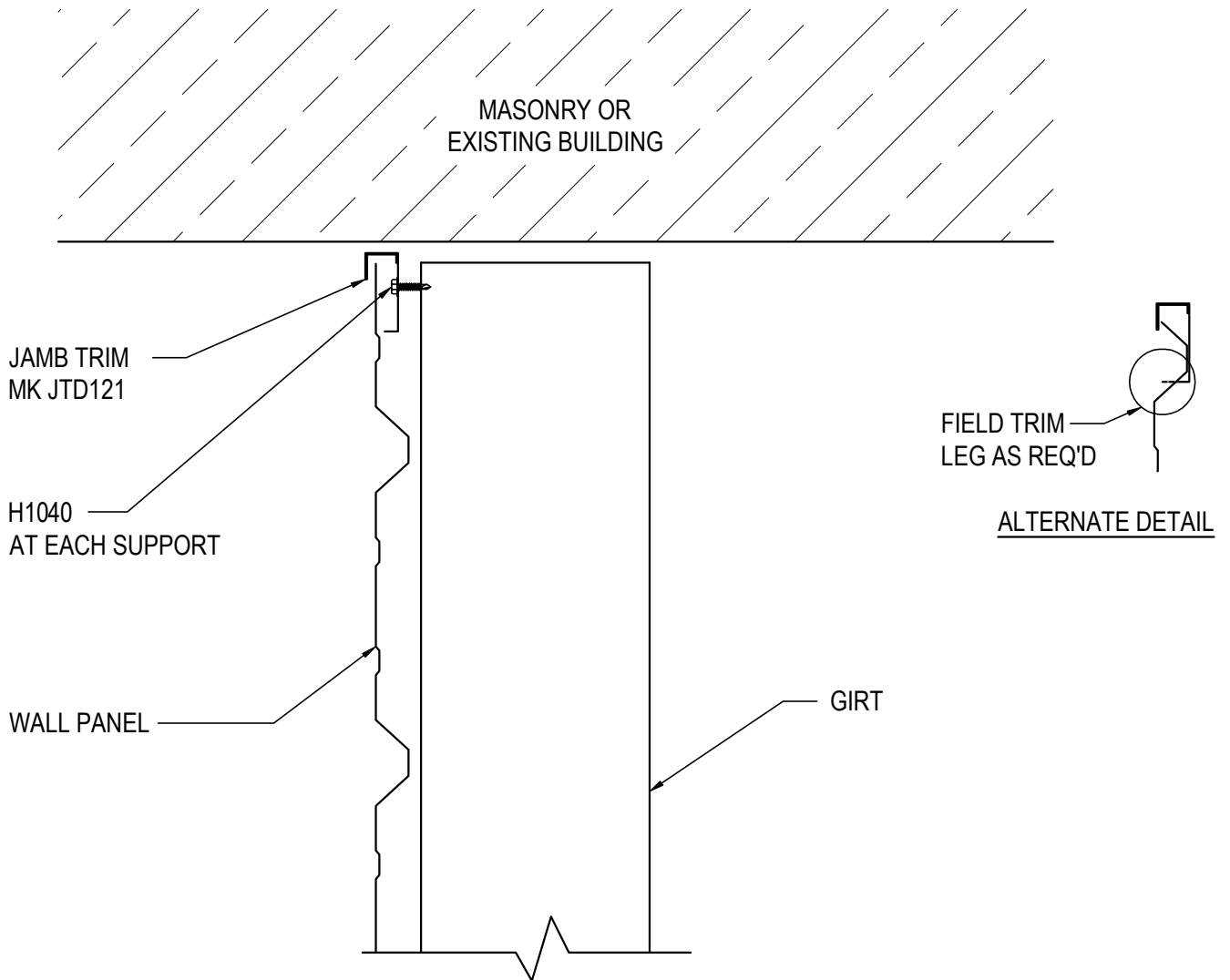

INSIDE CORNER TRANSITION

FIELD CUT PANELS AS REQUIRED

GC0091

Detailer Notes:

- 1) USE DETAIL GC0121 AS THE ALTERNATE TO THIS DETAIL

GC0092 - PANEL TERMINATION - REVERSE R-PANEL

[Download the DWG file by clicking here.](#)

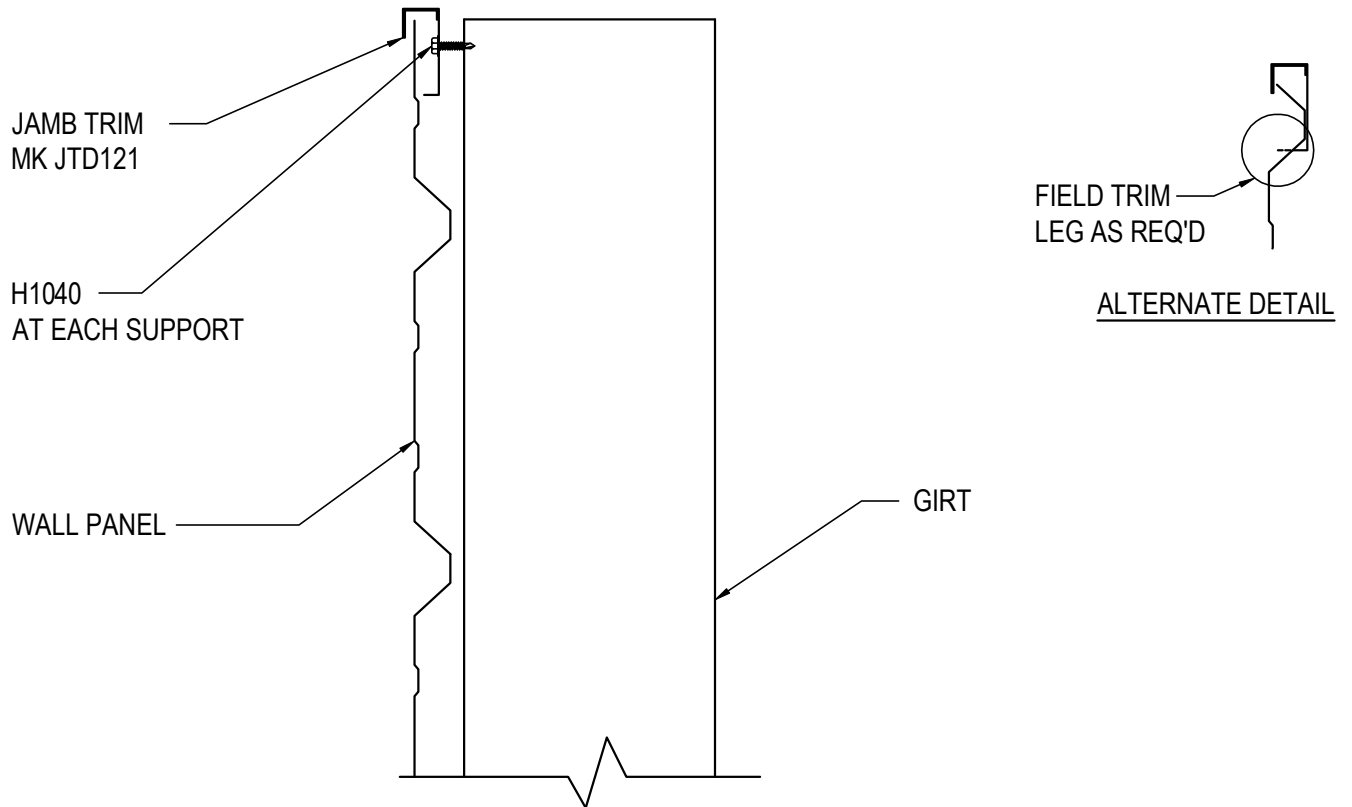

PANEL TERMINATION

FIELD CUT PANELS AS REQUIRED

GC0092

Detailer Notes:

- 1) N/A

GC0093 - PANEL TERMINATION W/ COVER TRIM - REVERSE R-PANEL

[Download the DWG file by clicking here.](#)

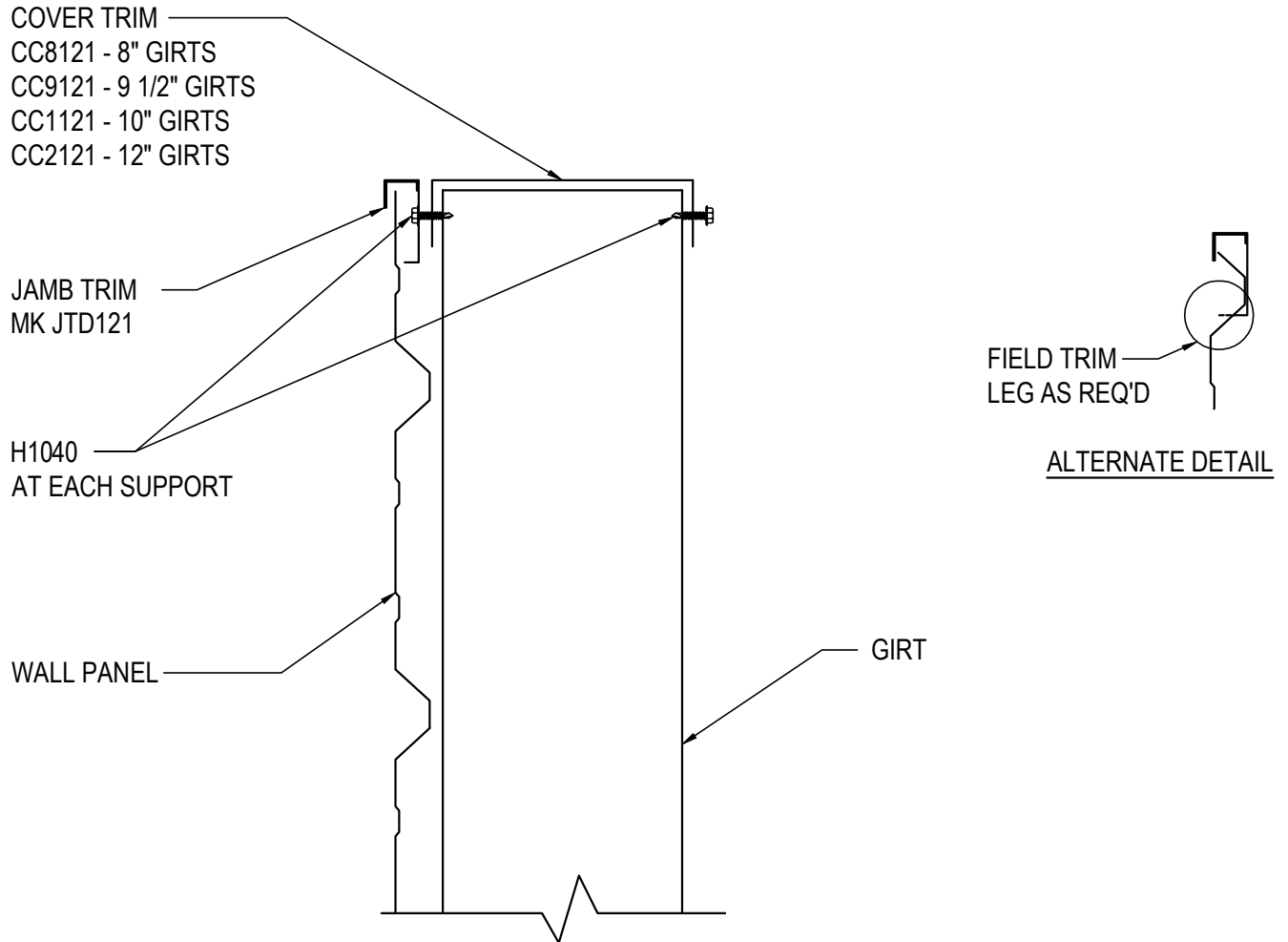

PANEL TERMINATION

FIELD CUT PANELS AS REQUIRED

GC0093

Detailer Notes:

1) N/A

GC0101 - INSIDE CORNER TRANSITION - A-PANEL

[Download the DWG file by clicking here.](#)

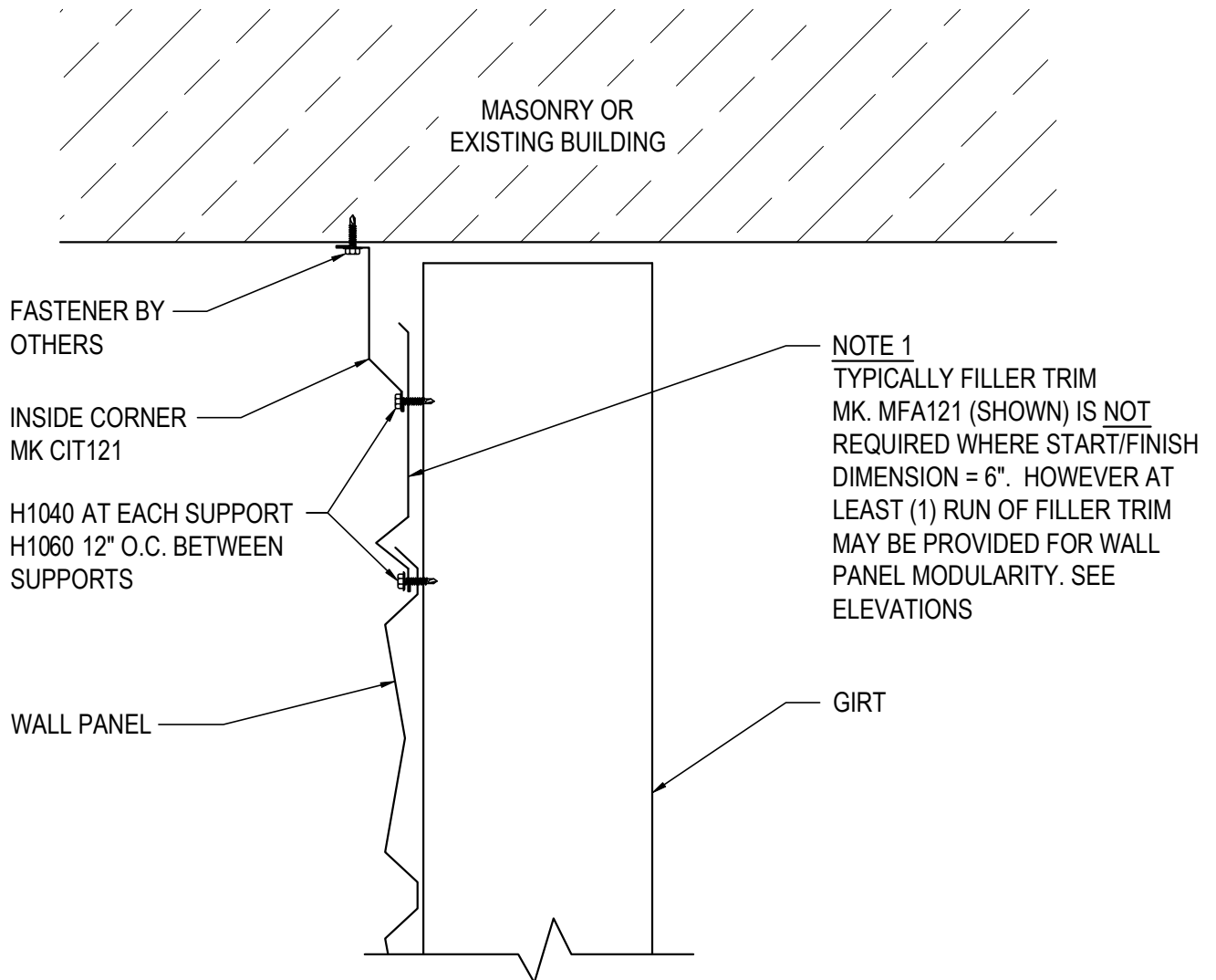

INSIDE CORNER TRANSITION

GC0101

Detailer Notes:

- 1) USE THIS DETAIL AS THE ALTERNATE TO DETAIL GC0071

GC0111 - INSIDE CORNER TRANSITION - R-PANEL

[Download the DWG file by clicking here.](#)

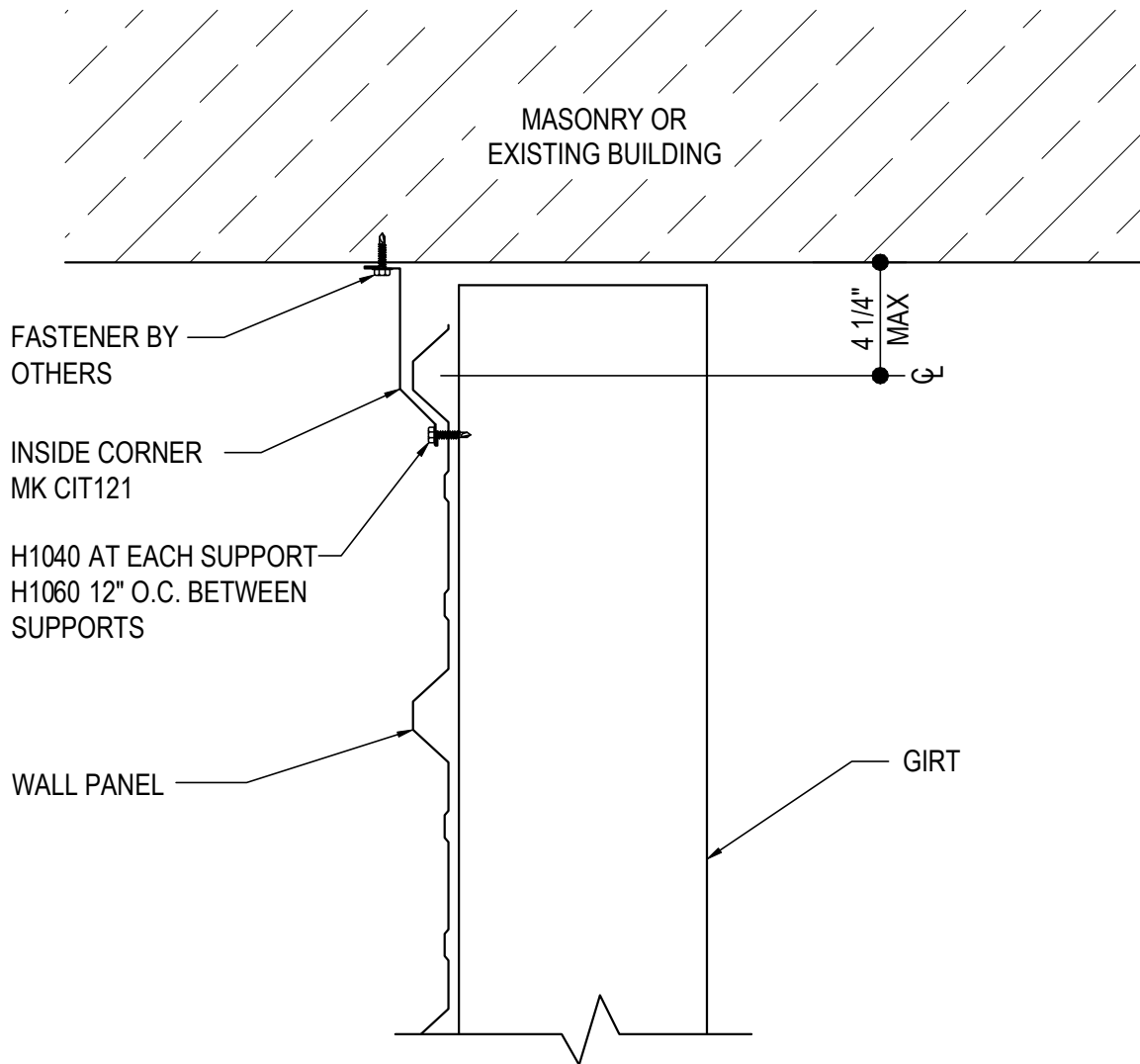

INSIDE CORNER TRANSITION

GC0111

Detailer Notes:

- 1) USE THIS DETAIL AS THE ALTERNATE TO DETAIL GC0081

GC0121 - INSIDE CORNER TRANSITION - REVERSE R-PANEL

[Download the DWG file by clicking here.](#)

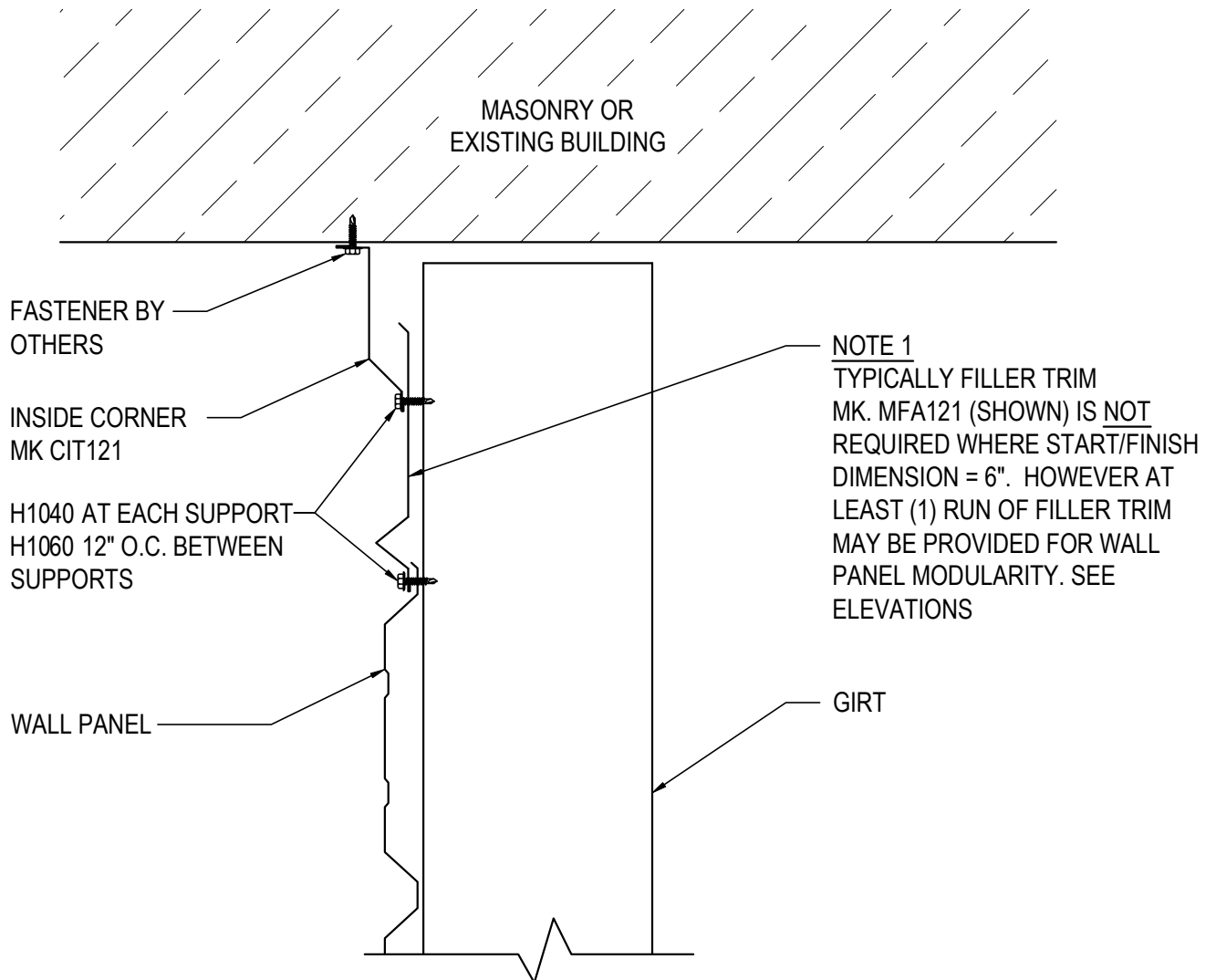

INSIDE CORNER TRANSITION

GC0121

Detailer Notes:

- 1) USE THIS DETAIL AS THE ALTERNATE TO DETAIL GC0091

GC0160 - OUTSIDE CORNER TRANSITION - MASONRY OR EXISTING - A-PANEL

[Download the DWG file by clicking here.](#)

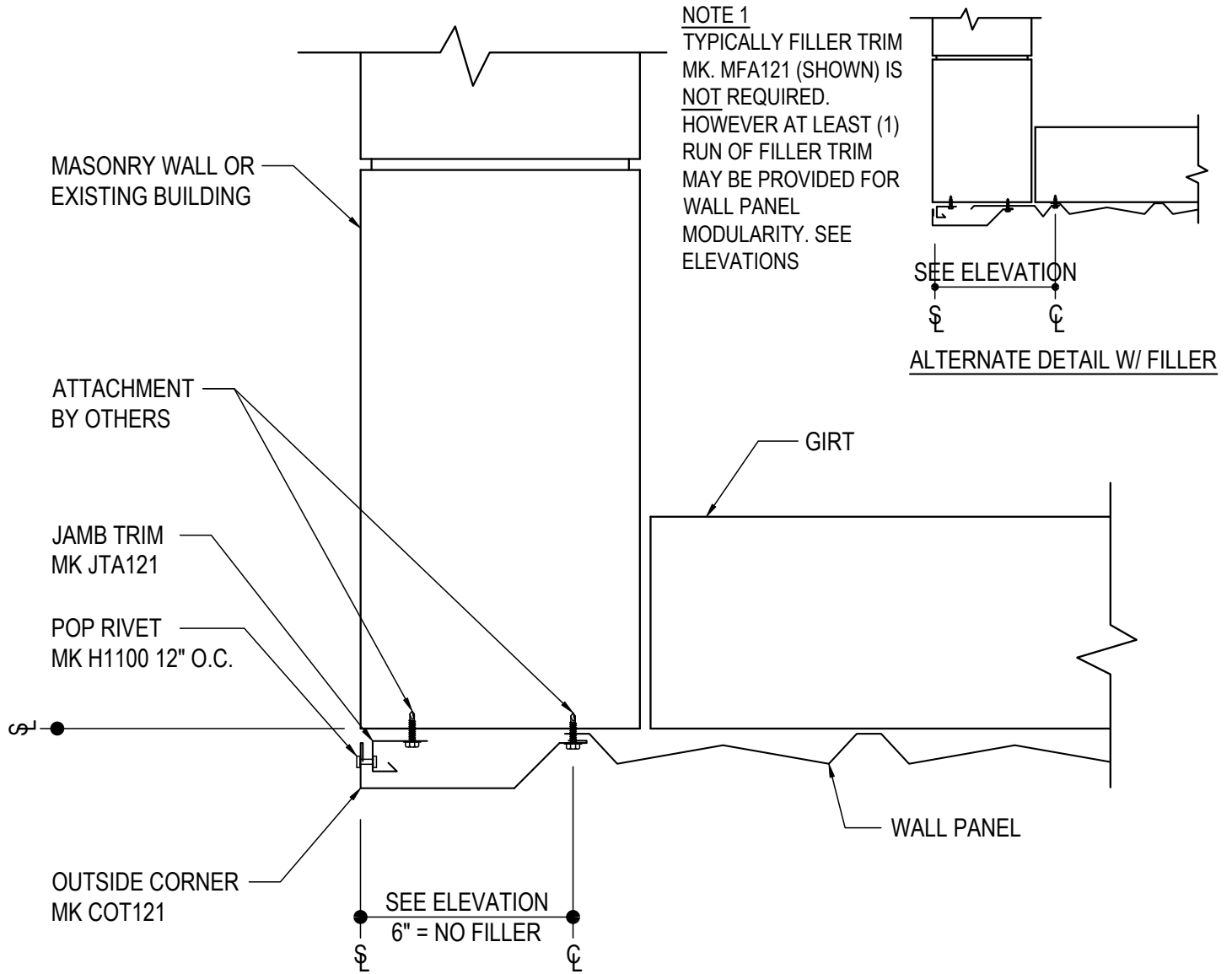

OUTSIDE CORNER TRANSITION

GC0160

Detailer Notes:

- 1) N/A

GC0170 - OUTSIDE CORNER TRANSITION - MASONRY OR EXISTING - R-PANEL

[Download the DWG file by clicking here.](#)

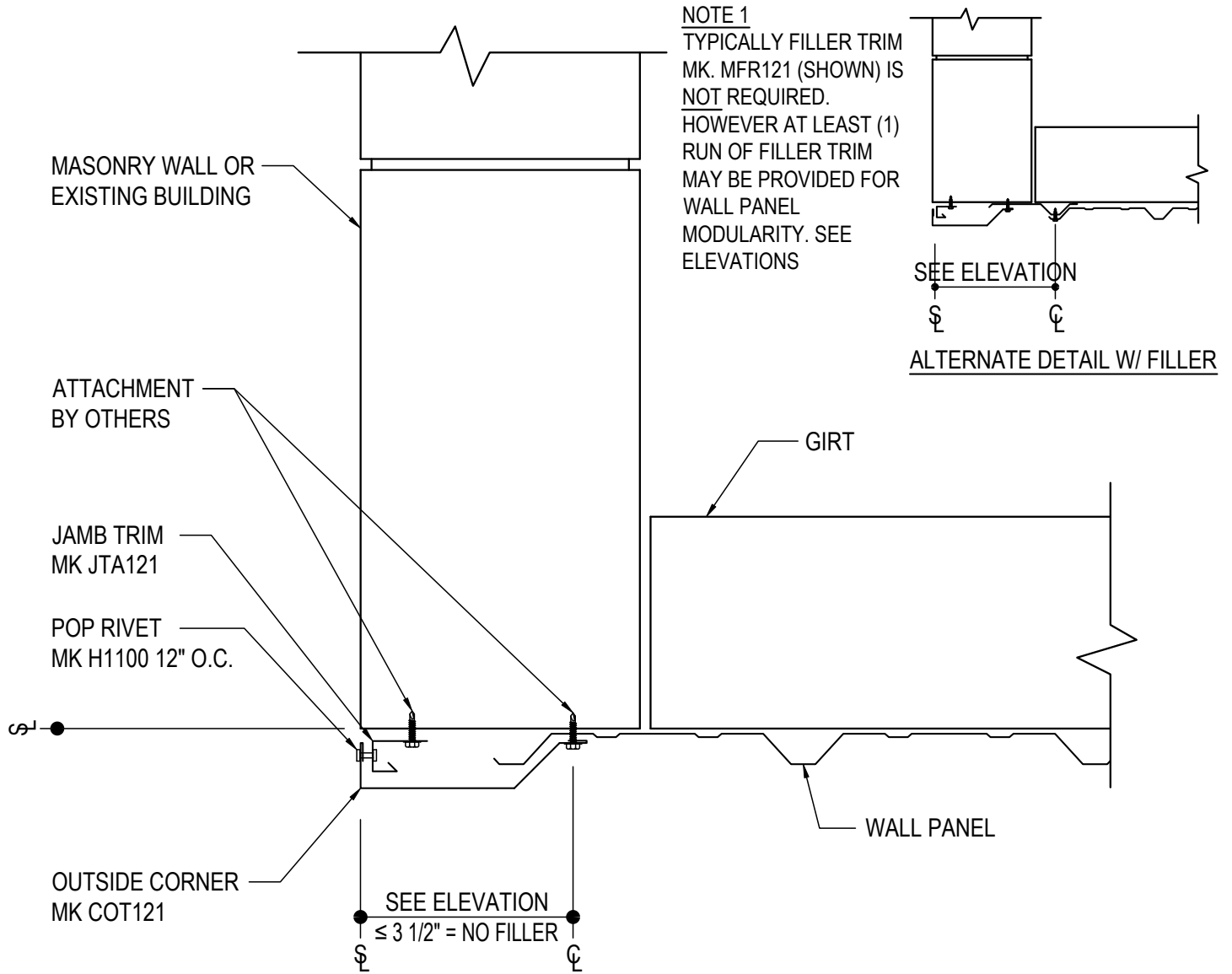

OUTSIDE CORNER TRANSITION

GC0170

Detailer Notes:

- 1) N/A

GC0180 - OUTSIDE CORNER TRANSITION - MASONRY OR EXISTING - REVERSE R-PANEL

[Download the DWG file by clicking here.](#)

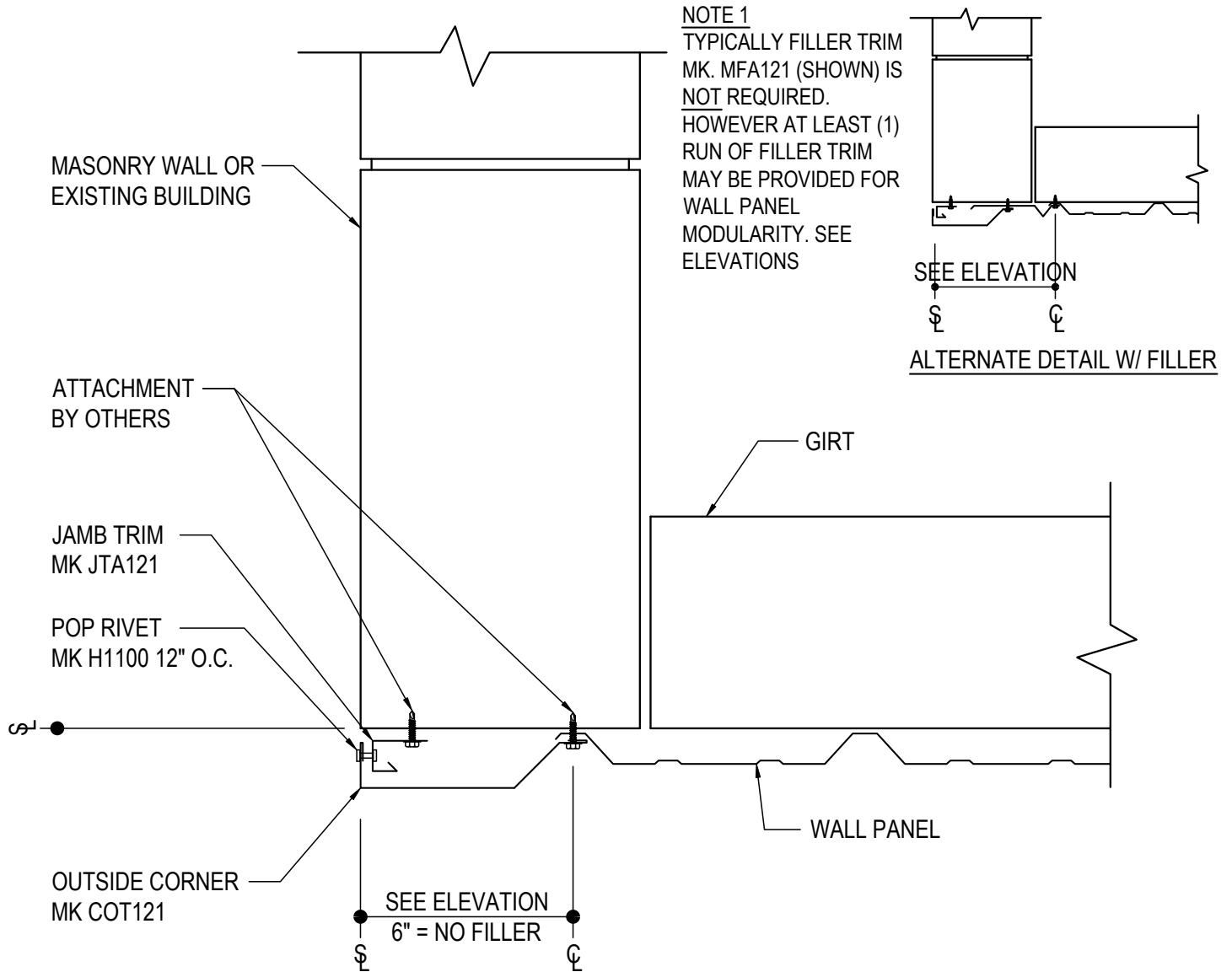

OUTSIDE CORNER TRANSITION

GC0180

Detailer Notes:

- 1) N/A

GC0211 - ALTERNATE OUTSIDE CORNER DETAIL - A-PANEL

[Download the DWG file by clicking here.](#)

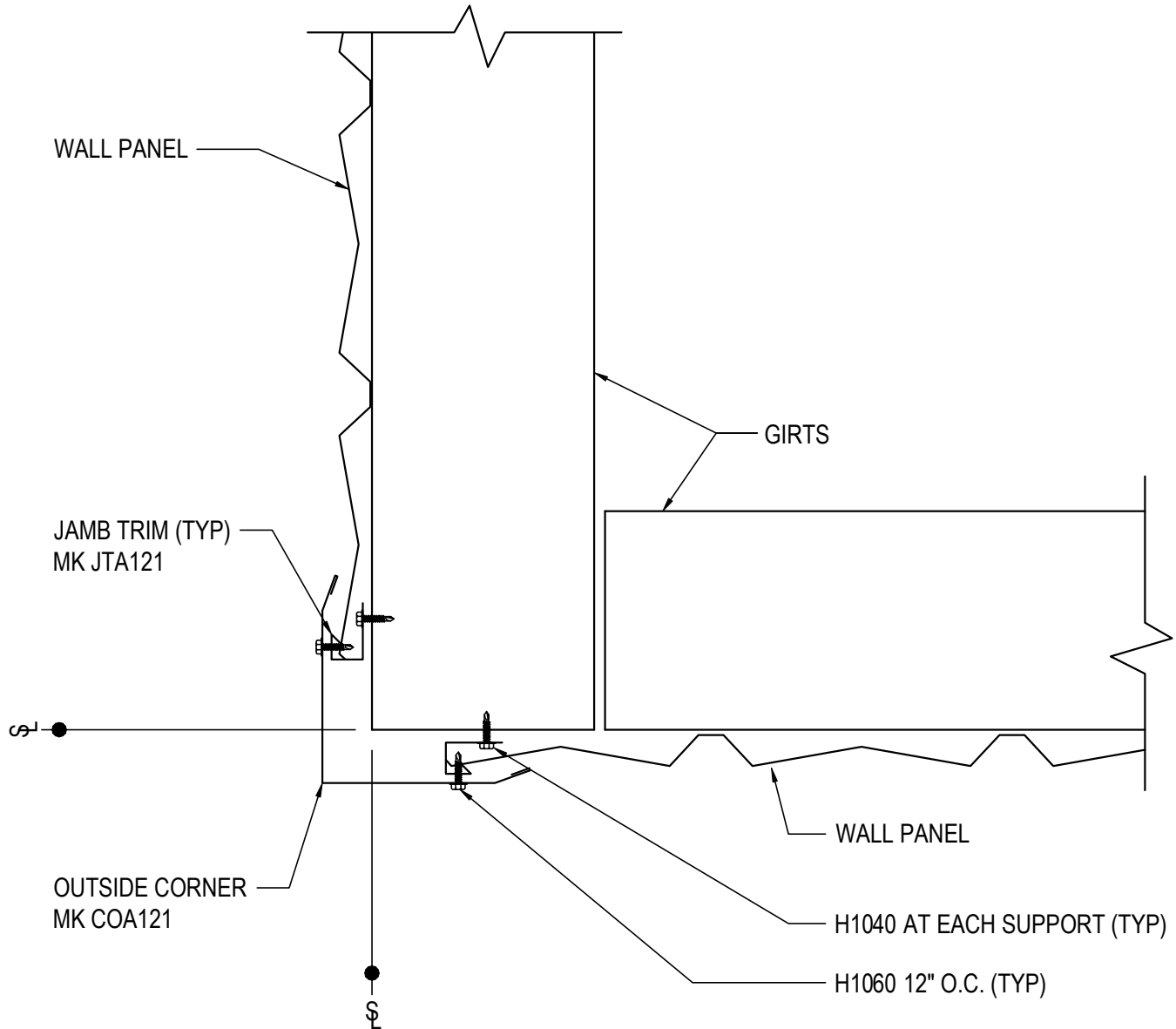

ALTERNATE OUTSIDE CORNER DETAIL

FIELD CUT PANELS AS REQUIRED

GC0211

Detailer Notes:

- 1) N/A

GC0221 - ALTERNATE OUTSIDE CORNER DETAIL - R-PANEL

[Download the DWG file by clicking here.](#)

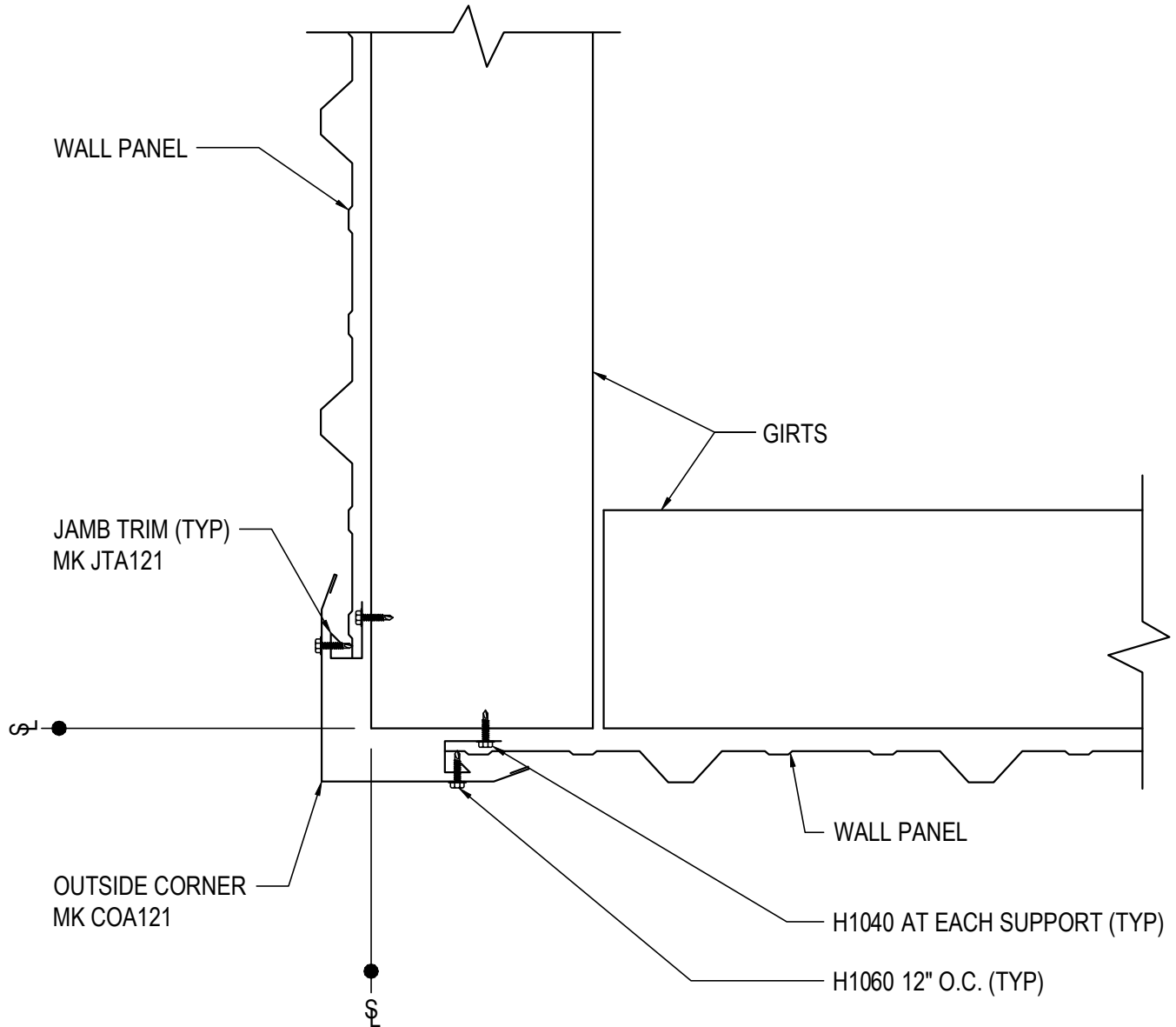

ALTERNATE OUTSIDE CORNER DETAIL

FIELD CUT PANELS AS REQUIRED

GC0221

Detailer Notes:

- 1) N/A

GC0231 - ALTERNATE OUTSIDE CORNER DETAIL - REVERSE R-PANEL

[Download the DWG file by clicking here.](#)

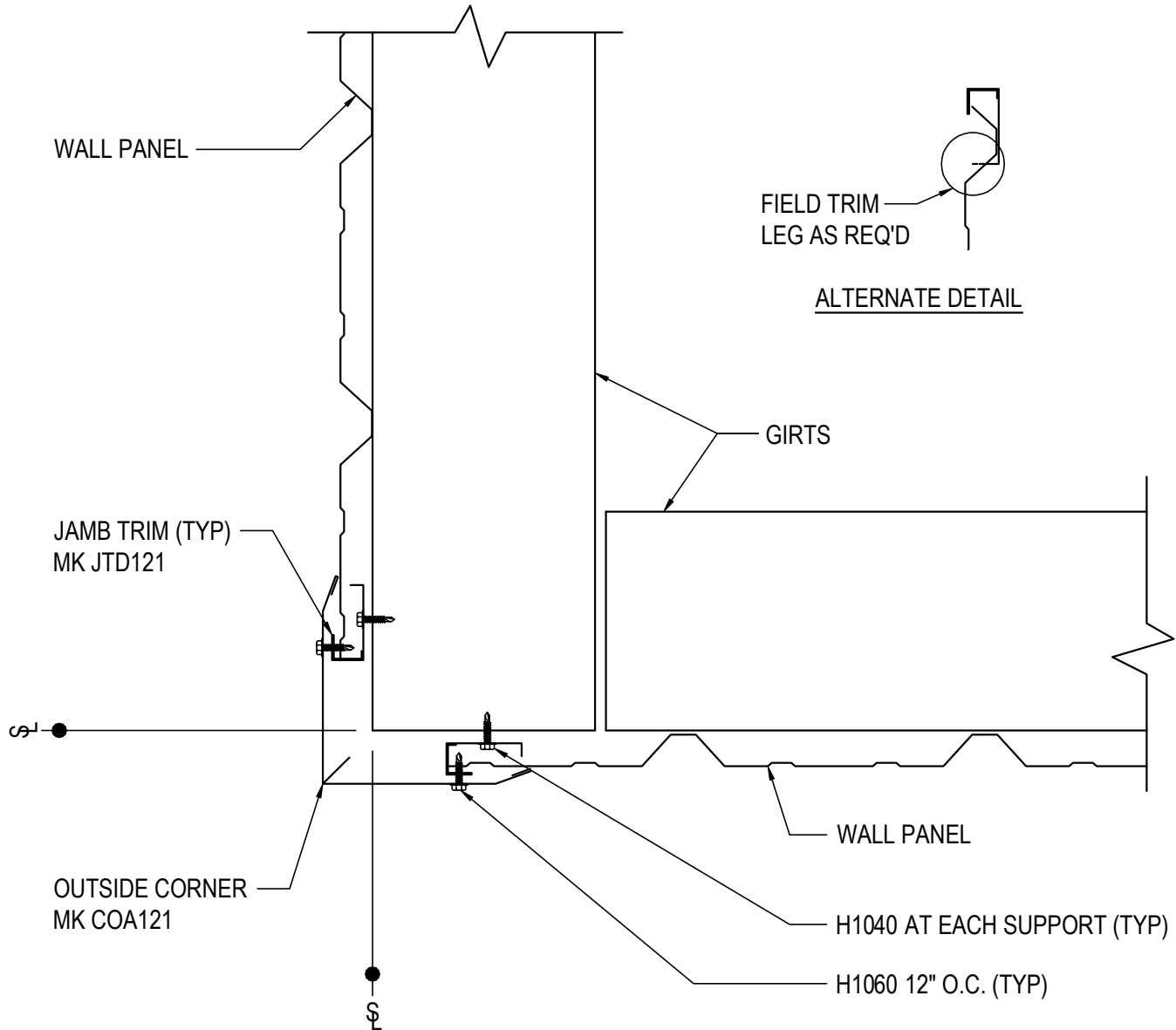

ALTERNATE OUTSIDE CORNER DETAIL

FIELD CUT PANELS AS REQUIRED

GC0231

Detailer Notes:

- 1) N/A

GC0241 - ALTERNATE INSIDE CORNER DETAIL - A-PANEL

[Download the DWG file by clicking here.](#)

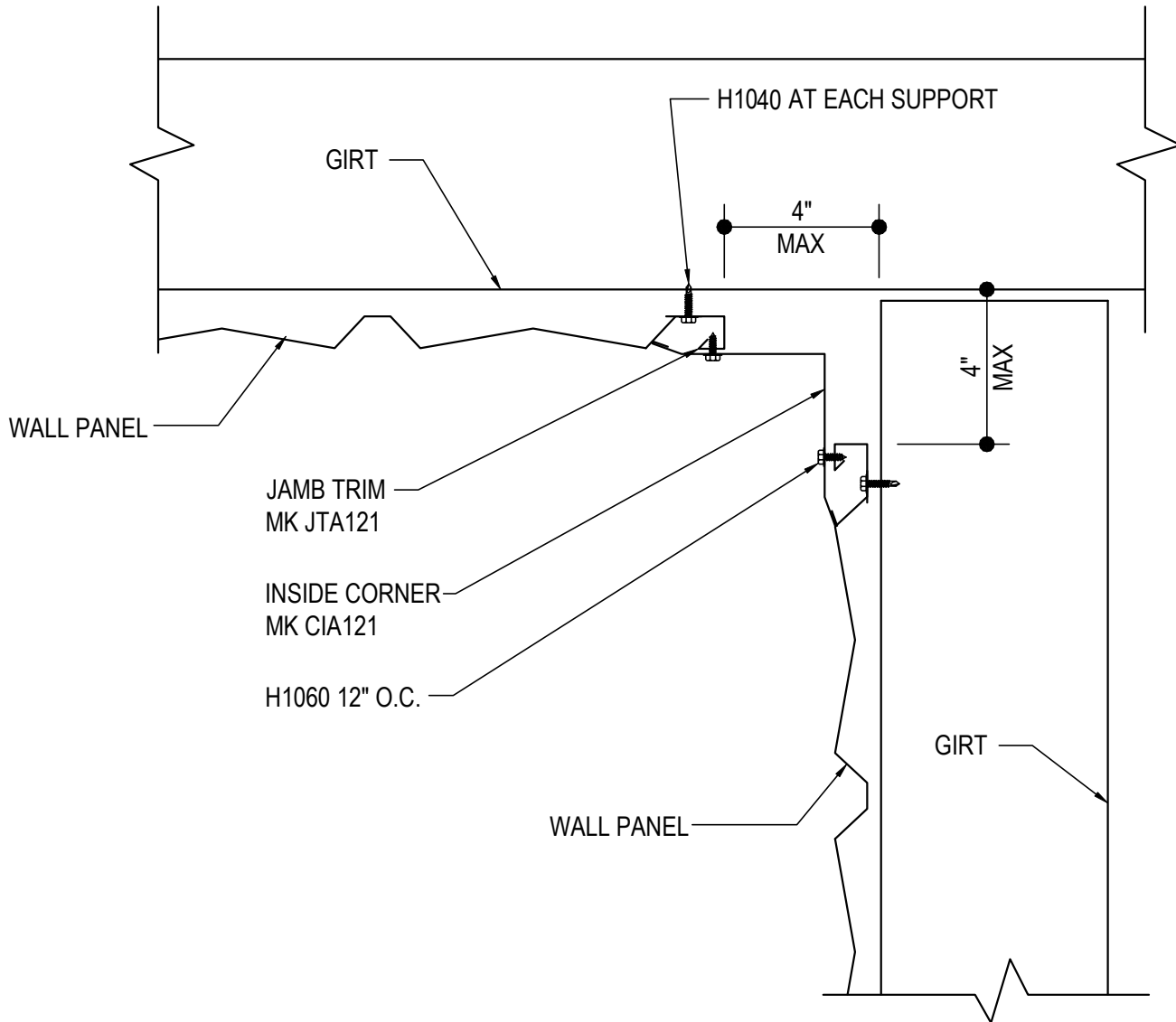

ALTERNATE INSIDE CORNER DETAIL

FIELD CUT PANELS AS REQUIRED

GC0241

Detailer Notes:

- 1) N/A

GC0251 - ALTERNATE INSIDE CORNER DETAIL - R-PANEL

[Download the DWG file by clicking here.](#)

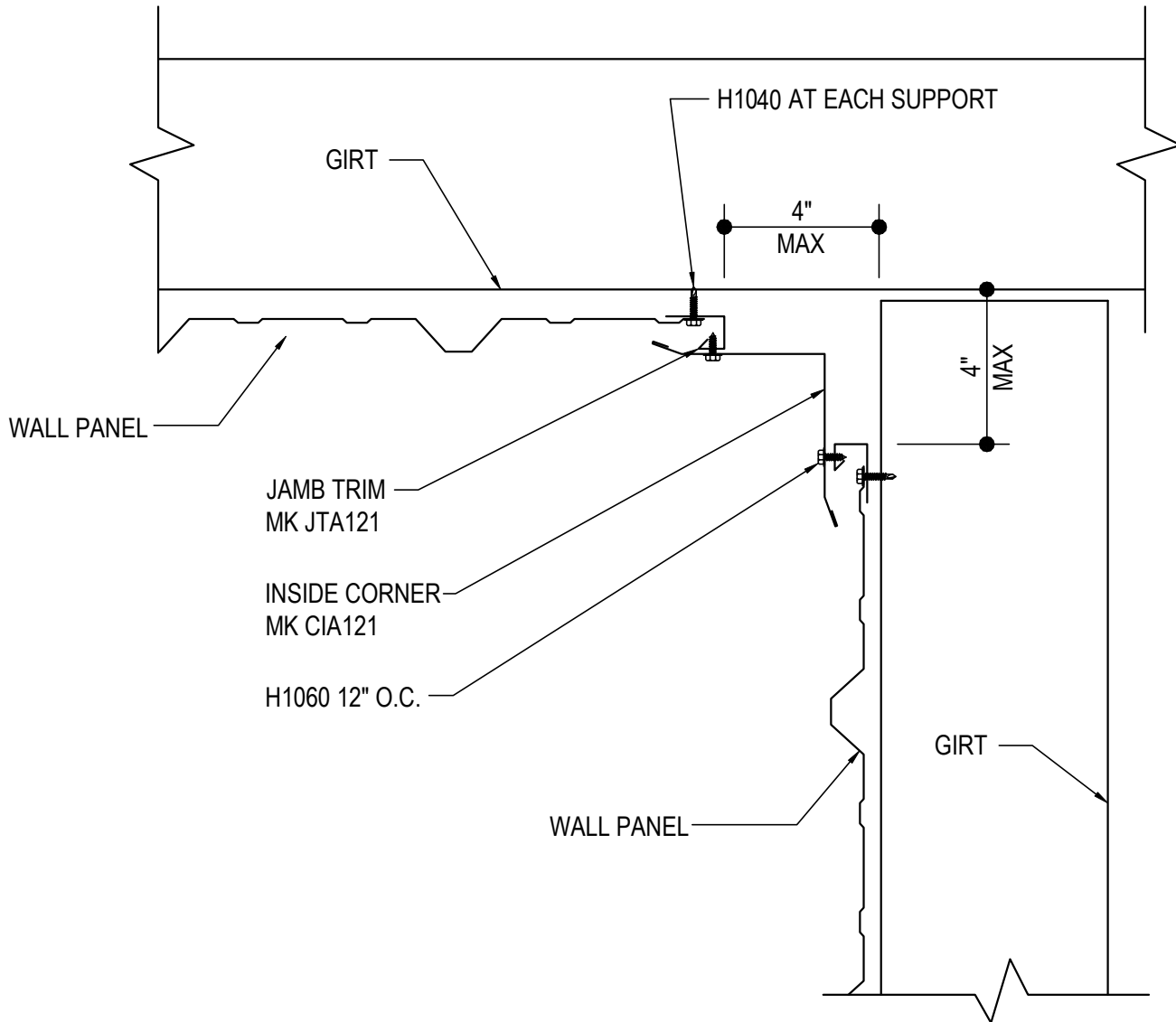

ALTERNATE INSIDE CORNER DETAIL

FIELD CUT PANELS AS REQUIRED

GC0251

Detailer Notes:

- 1) N/A

GC0261 - ALTERNATE INSIDE CORNER DETAIL - REVERSE R-PANEL

[Download the DWG file by clicking here.](#)

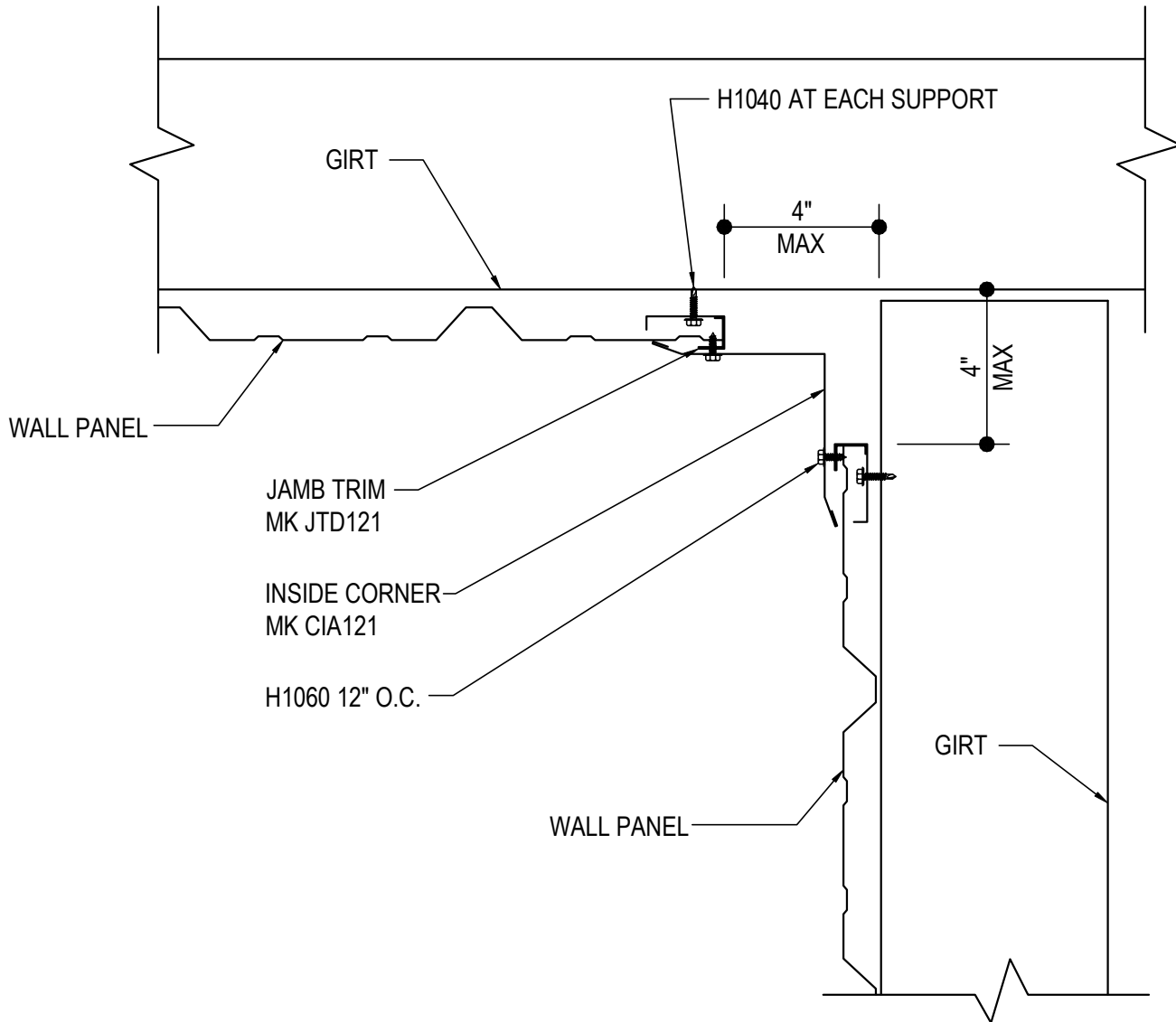

ALTERNATE INSIDE CORNER DETAIL

FIELD CUT PANELS AS REQUIRED

GC0261

Detailer Notes:

- 1) N/A